

User Manual



SAFEMASTER PRO

The configurable safety system
– versatile and extendable

DOLD 

Our experience. Your safety.

CONFIGURABLE SAFETY SYSTEM SAFEMASTER PRO

CONTENTS

INTRODUCTION	5
Contents of this handbook.....	5
Important safety instructions	5
Abbreviations and symbols	6
Applicable standards.....	6
OVERVIEW	7
Control unit and I/O expansion modules.....	8
Speed monitoring modules UG6917	8
Fieldbus modules.....	8
BusExtender module UG6918.....	9
PRODUCT COMPOSITION.....	10
INSTALLATION.....	10
Mechanical fastening.....	10
Electrical connections	11
USB input.....	11
SAFEMASTER PRO Memory chip OA6911	12
MULTIPLE LOAD function.....	12
RESTORE function	12
Connection terminals.....	13
Instructions concerning connection cables.	13
Connection terminals, control unit UG6911.10	14
Connection terminals, Input/Output module UG6916.10.....	14
Connection terminals, input module UG6913.16 with 16 inputs.....	15
Connection terminals, input module UG6913.12 with 12 inputs.....	16
Connection terminals, input module UG6913.08 with 8 inputs.....	16
Connection terminals, output module OSSD UG6912.04 with 4 OSSD	17
Connection terminals, output module OSSD UG6912.02 with 2 OSSD	17
Connection terminals, output module relay UG6912.28 with 2 OSSD	18
Connection terminals, output module relay UG6912.14 with 1 OSSD	18
Connection terminals, output module relay UG6914.04/000.....	19
Connection terminals, output module relay UG6914.04/008.....	19
Connection terminals, Speed monitoring module UG6917	20
Encoder connections (RJ45) Speed monitoring module UG6917.....	20
Connection terminals, BusExtender module UG6918.....	20
EXAMPLE OF CONNECTION TO THE MACHINE CONTROL SYSTEM.....	21
Calculation of safety distance of an ESPE connected to SAFEMASTER PRO	22
CHECKLIST AFTER INSTALLATION	22
PROJECT development DIAGRAM	23
SIGNALS.....	24
INPUTS.....	24
MASTER ENABLE	24
NODE SEL.....	24
PROXIMITY INPUT FOR SPEED CONTROLLER	24
RESTART_FBK	25
OUTPUTS.....	26
OUT STATUS	26
OUT TEST	26
OSSD (control unit UG6911.10, input/output module UG6916.10)	26
OSSD (output module OSSD UG6912.02, UG6912.04) with 2/4 OSSD	26
SAFETY RELAYS (output module relay UG6912.14, UG6912.28 with 1/2 OSSD).....	27
Characteristics of the output circuit.....	27

Internal contacts diagram	28
Example: connection static OSSD outputs from control unit UG6911.10 to output module relay UG6912.14 with 1 OSSD ²⁾	28
Switching operation timing diagram	29
TECHNICAL FEATURES	30
GENERAL SYSTEM CHARACTERISTICS	30
Safety level parameters	30
General data	30
Enclosure	32
Mechanical dimensions	32
Control unit UG6911.10	33
Input/output module UG6916.10 IO	34
Input modules UG6913.08 - UG6913.16 with 8 / 16 inputs	35
Input modules UG6913.13 with 12 inputs	35
Output modules OSSD UG6912.02 - UG6912.04 with 2/4 OSSD	36
Output module relay UG6912.14 - UG6912.28 with 1/2 OSSD	37
Output module relay UG6914.04/000 - UG6914.04/008	38
Speed monitoring module UG6917	40
BusExtender module UG6918	41
Cable for BusExtender Module UG6918	41
Visualisations	42
Control unit UG6911.10	42
Input/output module UG6916.10	43
Input modules UG6913.08, UG6913.12, UG6913.16, with 8, 12 and 16 inputs	44
Output module UG6912.02, UG6912.04, with 2 or 4 OSSD	45
Output module relay UG6912.14/ UG6912.28 with 1/2 OSSD	46
Output module relay UG6914.04/000, UG6914.04/008	47
Speed monitoring module UG6917/002, UG6917/x02, UG6917/xx2	48
BusExtender module UG6918	49
Troubleshooting	50
Control unit UG6911.10	50
Input/output module UG6916.10	51
Input module UG6913.08, UG6913.12, UG6913.16 with 8, 12 or 16 inputs	52
Output modules UG6912.02 / UG6912.04 with 2/4 OSSD	53
Output module relay UG6914.04/000, UG6914.04/008	54
Speed monitoring module UG6917/002, UG6917/x02, UG6917/xx2	55
BusExtender module UG6918	56
SAFEMASTER PRO DESIGNER SOFTWARE	57
Installing the software	57
PC HARDWARE requirements	57
PC SOFTWARE requirements	57
How to install SAFEMASTER PRO DESIGNER	57
Fundamentals	58
Standard tool bar	59
Create a new project (configure the SAFEMASTER PRO system)	60
EDIT CONFIGURATION (composition of the various units)	61
Change user parameters	61
OBJECTS - OPERATOR - CONFIGURATION tool bars	61
Creating the diagram (Figure 16)	62
Use of mouse right button	63
ON BLOCK INPUT / OUTPUT	63
ON BLOCK OPERATORS	63
ON Input / Output TERMINALS	63
ON CONNECTION (WIRES)	63
Print logic diagram	64
Example of a project	65

Project validation.....	65
Project report	66
Connect to SAFEMASTER PRO	67
Sending the configuration to the SAFEMASTER PRO	67
Download a configuration from a SAFEMASTER PRO	67
Configuration LOG	68
System composition	68
Disconnecting System.....	68
Error codes from SAFEMASTER PRO Designer.....	69
MONITOR (I/O status in Textual)	70
MONITOR (I/O status in real time - textual - graphic)	71
Password protection.....	72
Level 1 password	72
Level 2 password	72
Password Change.....	72
TESTING the system	73
OBJECT FUNCTION BLOCKS	74
OUTPUT OBJECTS.....	74
OSSD (safety outputs)	74
RELAY (safety output).....	75
STATUS (signal output)	76
FIELDBUS PROBE	76
INPUT OBJECTS.....	77
E-STOP (emergency stop)	77
E-GATE (safety gate device).....	78
SINGLE E-GATE (Safety gate device)	79
LOCK FEEDBACK	80
ENABLE (enable key)	81
ESPE (optoelectronic safety light curtain / laser scanner)	82
FOOTSWITCH (safety pedal).....	83
MOD-SEL (safety selector).....	84
PHOTOCELL (safety photocell)	85
TWO-HAND (bimanual control)	86
SENSOR.....	87
S-MAT (safety mat)	88
SWITCH.....	89
ENABLING GRIP SWITCH	90
TESTABLE SAFETY DEVICE	92
SOLID STATE DEVICE.....	93
FIELDBUS INPUT	94
LLO, LL1	95
NETWORK IN	95
SPEED CONTROL TYPE FUNCTION BLOCKS.....	96
SPEED CONTROL.....	96
WINDOW SPEED CONTROL.....	99
STAND STILL	101
STAND STILL AND SPEED CONTROL.....	103
TEXT BLOCKS	105
COMMENTS	105
TITLE	105
OPERATOR FUNCTION BLOCKS	106
LOGICAL OPERATORS	106
AND	106
NAND.....	106
NOT	106
OR	107

NOR	107
XOR	107
XNOR	108
LOGICAL MACRO	108
MULTIPLEXER	109
MEMORY OPERATORS.....	110
D FLIP FLOP (max number = 16).....	110
SR FLIP FLOP	110
T FLIP FLOP.....	110
USER RESTART MANUAL (max number = 16 USER RESTART at all)	111
USER RESTART MONITORED (max number = 16 USER RESTART at all)	111
MACRO RESTART MANUAL (max number = 16 USER RESTART at all)	111
MACRO RESTART MONITORED (max number = 16 USER RESTART at all)	112
GUARD LOCK OPERATORS	112
GUARD LOCK.....	112
COUNTER OPERATORS.....	114
COUNTER (max number = 16).....	114
TIMER OPERATORS (max number = 16).....	114
CLOCKING	114
MONOSTABLE	115
MONOSTABLE_B.....	116
PASSING MAKE CONTACT	117
DELAY	117
DELAY LINE	118
MUTING OPERATORS (max number = 4).....	120
"Concurrent" MUTING.....	120
MUTING "L"	121
"Sequential" MUTING.....	122
MUTING "T"	123
MUTING OVERRIDE (max number = 4)	123
Miscellany (special function Blocks)	125
Serial output.....	125
Network.....	126
RESET UG6911	129
INTERPAGE IN / OUT	129
RESET UG6911.....	129
SPECIAL APPLICATIONS.....	130
Combination of Two Hand with other safety functions	131
SIMULATOR	132
Schematic Simulation.....	132
Graphic Simulation.....	133
ACCESSORIES AND SPARE PARTS	137
Liability	138
Declaration of conformity.....	139

INTRODUCTION

Contents of this handbook

This handbook describes how to use the SAFEMASTER PRO programmable safety integrated controller and its expansion units;









It includes:

- a description of the system
- method of installation
- connections
- signals
- troubleshooting
- use of the configuration software

Important safety instructions

 This safety alert symbol indicates a potential **personal safety hazard**. Failure to comply with instructions bearing this symbol could pose a very serious risk to personnel.

 This symbol indicates an important instruction.

-  SAFEMASTER PRO is built to the following safety levels: SIL 3, SILCL 3, PL e, Cat. 4, Type 4 in accordance with the applicable standards. However, the definitive SIL and PL of the application will depend on the number of safety components, their parameters and the connections that are made, as per the risk analysis.
-  Read the "Applicable Standards" section carefully.
-  Perform an in-depth risk analysis to determine the appropriate safety level for your specific application, on the basis of all the applicable standards.
-  Programming/configuration of the Mosaic is the sole responsibility of the installer or user.
-  The device must be programmed/configured in accordance with the application-specific risk analysis and all the applicable standards.
-  Always test the complete system whenever new safety components are added (see the "**TESTING the system**" section).
-  Reference should be made to the handbooks and the relative product and/or application standards to ensure correct use of devices connected to the Mosaic within the specific application.
-  The ambient temperature in the place where the system is installed must be compatible with the operating temperature parameters stated on the product label and in the specifications.
-  For all matters concerning safety, if necessary, contact your country's competent safety authorities or the competent trade association.

Abbreviations and symbols

OSSD =	Output Signal Switching Device: <i>solid state safety output</i>
MTTF_d =	Mean Time to Dangerous Failure
PL =	Performance Level
PFH_d =	Probability of a dangerous failure per Hour
SIL =	Safety Integrity Level
SILCL =	Safety Integrity Level Claim Limit

Applicable standards

SAFEMASTER PRO complies with the following European Directives:

- **2006/42/EC** "Machinery Directive"
- **2004/108/EC** "Electromagnetic Compatibility Directive"
- **2006/95/EC** "Low Voltage Directive"

and is built to the following standards:

DIN EN 61131-2	Programmable controllers, part 2: Equipment requirements and tests
DIN EN ISO 13849-1	Safety of machinery: Safety related parts of control systems. General principles for design
DIN EN 61496-1	Safety of machinery: Electro-sensitive protective equipment. Part 1: General requirements and tests.
DIN EN 61508-1	Functional safety of electrical/electronic/programmable electronic safety-related systems: General requirements.
DIN EN 61508-2	Functional safety of electrical/electronic/programmable electronic safety-related systems: Requirements for electrical/electronic/programmable electronic safety-related systems.
DIN EN 61508-3	Functional safety of electrical/electronic/programmable electronic safety-related systems: Software requirements.
DIN EN 61784-3	Digital data communication for measurement and control: Functional safety fieldbuses.
DIN EN 62061	Safety of machinery. Functional safety of safety-related electrical, electronic and programmable electronic control systems

Table 1

OVERVIEW

SAFEMASTER PRO is a configurable safety system. It consists of a control unit **UG6911.10**, which can be configured using the SAFEMASTER PRO DESIGNER graphic interface, and a number of expansion modules connected to the control unit UG6911.10 via the proprietary IN-RAIL-BUS.

The control unit UG6911.10 can also be used as a stand-alone device. It has 8 safety inputs and 2 independent programmable dual channel outputs.

- ➔ The following expansions are available: input/output module (**UG6916.10**), input modules (**UG6913.08, UG6913.12 and UG6913.16**), output modules OSSD (**UG6912.02 and UG6912.04**) with dual channel semiconductor outputs, output modules relays with guided contact safety relays (**UG6914.04/000, UG6914.04/008, UG6912.14 und UG6912.28**), and **several speed monitoring modules (UG6917/xx2)**.
- ➔ The BusExtender module **UG6918** allows a decentralized system with module connection at great distance.
- ➔ For diagnostic over the main fieldbus, following fieldbus modules are available: **UG6951** (CanOpen), **UG6952** (PROFIBUS), **UG6954** (PROFINET), **UG6955** (Ethernet IP), **UG6956** (EtherCAT) and **UG6957** (Universal Serial BUs).

For more detailed information, consult the fieldbus manual on the SAFEMASTER PRO Designer CD-ROM

SAFEMASTER PRO is capable of monitoring the following safety sensors and commands: Optoelectronic sensors (safety light curtains, scanners, safety photocells), mechanical switches, safety mats, emergency stops, two-hand controls, all managed by a single flexible and expandable device.

The system must consist of just one control unit UG6911.10 and a number of electronic expansions that can range from 0 to a maximum of 14, not more than 4 of which of the same type. There is no limit to the number of relay units that can be installed.

With 14 expansions, the system can have up to 128 inputs, 16 dual channel safety outputs and 16 Status outputs. The CONTROL UNIT and its SLAVE units communicate via the 5-pole IN-RAIL-BUS (proprietary bus), physically arranged on the rear panel of each unit.

Furthermore 8 inputs and 16 outputs probe controllable (by Fieldbus) are available.

The SAFEMASTER PRO DESIGNER software is capable of creating complex logics, using logical operators and safety functions such as muting, timer, counters, etc.

All this is performed through an easy and intuitive graphic interface.

The configuration performed on the PC is sent to the control unit UG6911.10 via USB connection; the file resides in the control unit UG6911.10 and can also be saved on the proprietary OA6911 memory chip (accessory). The configuration can therefore quickly be copied to another control unit UG6911.10 unit.

- ➔ The SAFEMASTER PRO system is certified to the maximum safety level envisaged by the applicable industrial safety standards (SIL 3, SILCL 3, PL e, Cat. 4).

Control unit and I/O expansion modules

- The control unit UG6911.10 and the I/O Expansion module UG6916.10 have 8 safety inputs, 2 independent programmable dual channel safety outputs (OSSD), 2 status outputs and 4 test outputs to monitor the presence of short-circuits on the inputs.
- The input modules UG6913.08, UG6913.12 and UG6913.16 have respectively 8, 12 or 16 inputs. The modules UG6913.08 and UG6913.16 has 4 test outputs to monitor the presence of short-circuits on the inputs. The module UG6913.12 has 8 test outputs and can control up to 4-wire safety maps.
- The output modules UG6912.02 and UG6912.04 has respectively 2 or 4 independent programmable dual channel safety outputs (OSSD) and 2 or 4 status outputs.
- The relays output modules UG6912.14 and UG6912.28 provide the system with 2 and 4 N.O. guided contact safety relay outputs, respectively, with the related external relay feedback (N.C. contact).
They are not connected over the proprietary IN-RAIL-BUS but directly to the OSSD outputs from I/O modules with OSSD output.
- The relays output modules UG6914.04/000 and UG6914.04/008 are safety units provided with 4 independent safety relay outputs and the corresponding 4 inputs for the external feedback contacts (EDM).
There are two possible output settings (configured using the SAFEMASTZER PRO Designer configuration software).
- The speed monitoring modules UG6917 can be used to control the following (up to PLe):
 - Two pairs of connection contacts (2 N.O. contacts per output with 2 corresponding feedback inputs).
 - Four independent single connection contacts (1 N.O. contact per output with 1 corresponding feedback input).

Only the UG6914.04/008 module has 8 programmable status outputs.

Speed monitoring modules UG6917

- The speed monitoring modules UG6917 can be used to control the following (up to PLe):
 - Zero speed, Max. speed, Speed range;
 - Direction of movement, rotation/translation;

Up to 4 speed thresholds can be set for each logic output (axis).

Each unit incorporates two logic outputs that can be configured using the SAFEMASTZER PRO Designer configuration software and is thus capable of controlling up to two independent axes.

Fieldbus modules

- The fieldbus modules UG6951, UG6952, UG6954, UG6955, UG6956 and UG6957 permit the connection to the most commonly used industrial fieldbus systems for diagnostics and data transmission.
UG6957 permits connection to devices with a USB port.

BusExtender module UG6918

- UG6918 is an expansion module which allows the connection of the control unit UG6910.10 with other slave modules placed at great distances (<50m). Through the use of a shielded cable (**with RS485 compatible double twister pair shielded cable**) two BusExtender modules UG6918 placed at the desired distance can be linked together.

Each BusExtender module UG6918 has two independent connection channels; the connection of two BusExtender modules UG6918 can be performed by wiring a channel of your choice. The figure beside allows you to view an example of connection. The system response time does not change with the use of BusExtender modules UG6918.

➔ The system response time does not change with the use of module UG6918.

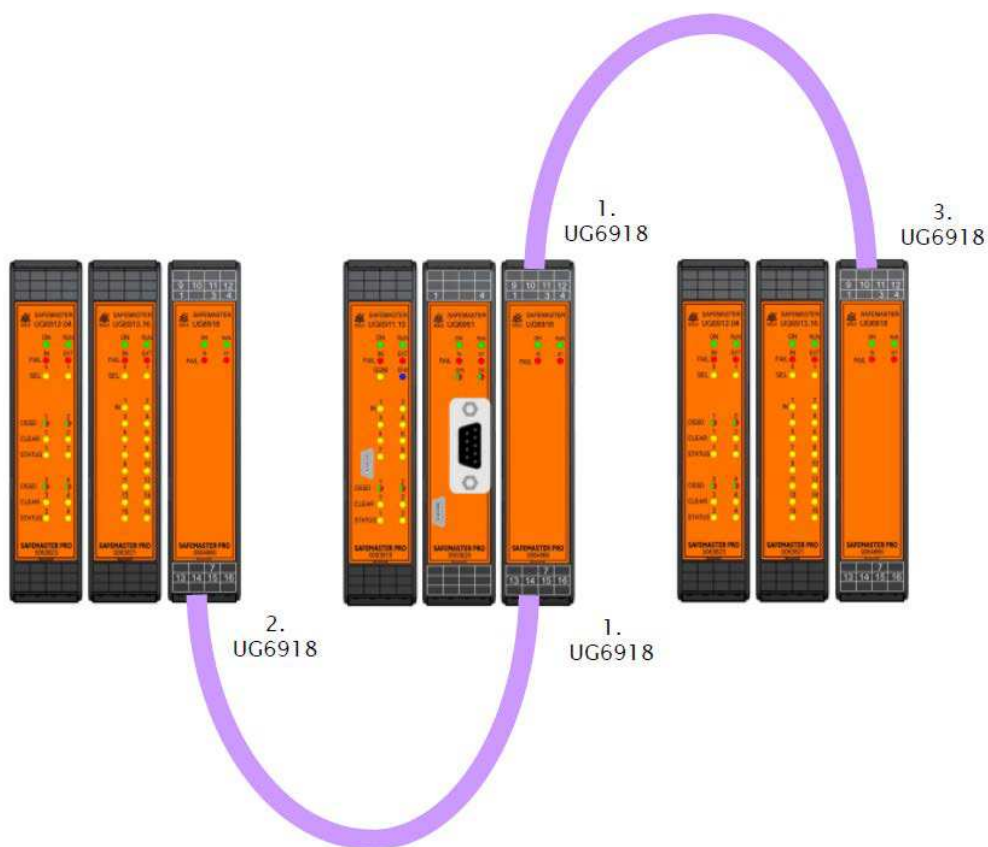

Figure 1

PRODUCT COMPOSITION

The control unit UG6911.10 is supplied with:

- CD-ROM containing the free SAFEMASTER PRO DESIGNER Software, this handbook in three languages as PDF file format.
- Multilingual installation sheet.

➔ The rear panel IN-RAIL-BUS and the memory chip OA6911 can be ordered separately as accessories.

The expansion units are supplied with:

- Multilingual Installation sheet.

➔ To install an expansion unit (except relay units) an IN-RAIL-BUS is necessary to connect them to the control unit UG6911.10. This bus (length 250 mm) can be ordered as accessory.

INSTALLATION

Mechanical fastening

Fix the SAFEMASTER PRO system units to a 35mm DIN rail as follows:

1. Fix the IN-RAIL-BUS to the DIN 35mm (EN 5022) rail.
2. Fasten the units to the rail, arranging the contacts on the base of the IN-RAIL-BUS. Press the unit gently until you feel it snap into place.
3. To remove a unit, use a screwdriver to pull down the locking latch on the back of the unit; then lift the unit upwards and pull.



Figure 2

Electrical connections

USB input

The SAFEMASTER PRO control unit UG6911.10 includes a USB 2.0 connector for connection to a Personal Computer where the **SAFEMASTER PRO DESIGNER** configuration software resides. A USB cable is available as an accessory (**OA6920**).

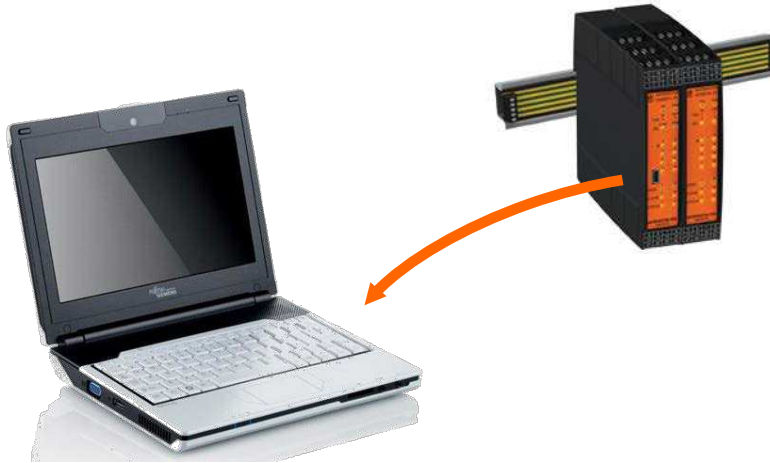
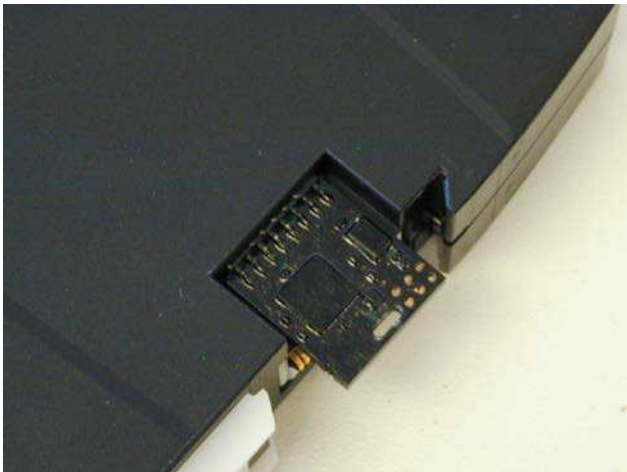
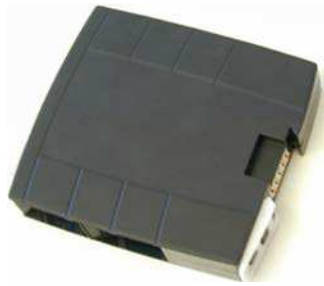

Figure 3 - USB 2.0 front panel connector

SAFEMASTER PRO Memory chip OA6911



Memory card
OA6911



A memory chip **OA6911** (optional) can be installed in the SAFEMASTER PRO control unit UG6911.10 and used to save the software configuration parameters.

The memory chip OA6911 is written **each time** a new project is sent from the PC to the control unit UG6911.10.

➔ Always switch the control unit UG6911.10 off before insert or remove the memory chip OA6911.

Insert the card in the **slot in the rear panel of the control unit UG6911.10** (as shown in figure 2).

MULTIPLE LOAD function

To perform the configuration of several control units UG6911.10 units without using a PC and the USB connector, you can save the desired configuration on a single memory chip OA6911 and then use it to download data on the control units UG6911.10 to be configured.

 If the file contained in the memory chip OA6911 is not identical to the one contained in control unit UG6911.10, an overwrite operation that will permanently delete the configuration data contained in the control unit will be performed.
WARNING: ALL DATA PREVIOUSLY CONTAINED IN THE CONTROL UNIT UG6911.10 WILL BE LOST.

RESTORE function

If the control unit UG6911.10 unit is damaged, you can replace it with a new one; having already saved all the configurations on the memory chip OA6911, all you need to do is insert the memory chip OA6911 in the new control unit UG6911.10 and switch on the SAFEMASTER PRO system, that will immediately load the backup configuration. In this way, the work interruptions will be minimized.

➔ The LOAD and RESTORE functions can be disabled via software (see "[Create a new project \(configure the SAFEMASTER PRO system\)](#)").

➔ In order to be used, the expansion units must be addressed at the time of installation (see the [NODE SEL](#) section).

English

 Each time the memory chip OA6911 is used, carefully check that the chosen configuration is the one that was planned for that particular system. Try again a fully functional test of the system composed of SAFEMASTER PRO plus all devices connected to it (see the [TESTING the system](#) section).

Connection terminals

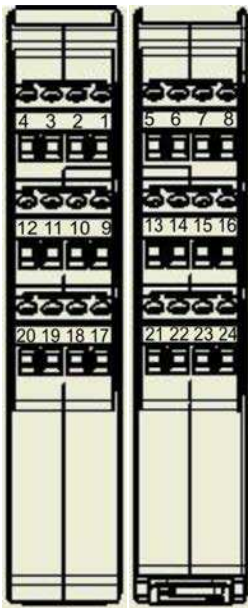





The SAFEMASTER PRO system units are provided with removable terminal blocks for the electrical connections. Each unit can have 8, 16 or 24 terminals.

Each unit also has a rear panel plug-in connector (for communication with the control unit and with the other expansion units).

The 1/2 OSSD safety relay units UG6912.14 and UG6912.28 are connected via terminal blocks only.



➔ Terminal tightening torque: 5÷7lb-in (0,6÷0,7Nm).

-  Install safety units in an enclosure with a protection class of at least IP54.
-  Connect and disconnect the module only when it is not powered
-  The supply voltage to the units must be 24VDC \pm 20% (PELV, in compliance with the standard EN 60204-1 (Chapter 6.4)).
-  Do not use the SAFEMASTER PRO to supply external devices.
-  The same power supply connection (24VDC and 0VDC) must be used for all system components.

Instructions concerning connection cables.

- ➔ Wire size range: AWG 12÷30, (solid/stranded) (UL).
- ➔ Use 60/75°C copper (Cu) conductor only.
- ➔ Cables used for connections of longer than 50m must have a cross-section of at least 1mm² (AWG16).
- ➔ We recommend the use of separate power supplies for the safety unit and for other electrical power equipment (electric motors, inverters, frequency converters) or other sources of disturbance.

Connections of each single SAFEMASTER PRO system unit are listed in the table below:

Connection terminals, control unit UG6911.10

TERMINAL	SIGNAL	TYPE	DESCRIPTION	OPERATION
1	24VDC	-	24VDC power supply	-
2	MASTER_ENABLE1	Input	Master Enable 1	"Type 2" according to EN 61131-2
3	MASTER_ENABLE2	Input	Master Enable 2	"Type 2" according to EN 61131-2
4	GND	-	0VDC power supply	-
5	OSSD1_A	Output	Static output 1	PNP active high
6	OSSD1_B	Output		PNP active high
7	RESTART_FBK1	Input	Feedback/Restart 1	"Type 2" according to EN 61131-2
8	OUT_STATUS1	Output	Programmable digital output	PNP active high
9	OSSD2_A	Output	Static output 2	PNP active high
10	OSSD2_B	Output		PNP active high
11	RESTART_FBK2	Input	Feedback/Restart 2	"Type 2" according to EN 61131-2
12	OUT_STATUS2	Output	Programmable digital output	PNP active high
13	OUT_TEST1	Output	Short circuit detection output	PNP active high
14	OUT_TEST2	Output	Short circuit detection output	PNP active high
15	OUT_TEST3	Output	Short circuit detection output	PNP active high
16	OUT_TEST4	Output	Short circuit detection output	PNP active high
17	INPUT1	Input	Digital input 1	"Type 2" according to EN 61131-2
18	INPUT2	Input	Digital input 2	"Type 2" according to EN 61131-2
19	INPUT3	Input	Digital input 3	"Type 2" according to EN 61131-2
20	INPUT4	Input	Digital input 4	"Type 2" according to EN 61131-2
21	INPUT5	Input	Digital input 5	"Type 2" according to EN 61131-2
22	INPUT6	Input	Digital input 6	"Type 2" according to EN 61131-2
23	INPUT7	Input	Digital input 7	"Type 2" according to EN 61131-2
24	INPUT8	Input	Digital input 8	"Type 2" according to EN 61131-2

Table 2

Connection terminals, Input/Output module UG6916.10

TERMINAL	SIGNAL	TYPE	DESCRIPTION	OPERATION
1	24VDC	-	24VDC power supply	-
2	NODE_SEL0	Input	Node selection	Input ("Type 2" according to EN 61131-2)
3	NODE_SEL1	Input		Input ("Type 2" according to EN 61131-2)
4	GND	-	0VDC power supply	-
5	OSSD1_A	Output	Static output 1	PNP active high
6	OSSD1_B	Output		PNP active high
7	RESTART_FBK1	Input	Feedback/Restart 1	Input ("Type 2" according to EN 61131-2)
8	OUT_STATUS1	Output	Programmable digital output	PNP active high
9	OSSD2_A	Output	Static output 2	PNP active high
10	OSSD2_B	Output		PNP active high
11	RESTART_FBK2	Input	Feedback/Restart 2	Input ("Type 2" according to EN 61131-2)
12	OUT_STATUS2	Output	Programmable digital output	PNP active high
13	OUT_TEST1	Output	Short circuit detection output	PNP active high
14	OUT_TEST2	Output	Short circuit detection output	PNP active high
15	OUT_TEST3	Output	Short circuit detection output	PNP active high
16	OUT_TEST4	Output	Short circuit detection output	PNP active high
17	INPUT1	Input	Digital input 1	Input ("Type 2" according to EN 61131-2)
18	INPUT2	Input	Digital input 2	Input ("Type 2" according to EN 61131-2)
19	INPUT3	Input	Digital input 3	Input ("Type 2" according to EN 61131-2)
20	INPUT4	Input	Digital input 4	Input ("Type 2" according to EN 61131-2)
21	INPUT5	Input	Digital input 5	Input ("Type 2" according to EN 61131-2)
22	INPUT6	Input	Digital input 6	Input ("Type 2" according to EN 61131-2)
23	INPUT7	Input	Digital input 7	Input ("Type 2" according to EN 61131-2)
24	INPUT8	Input	Digital input 8	Input ("Type 2" according to EN 61131-2)

Table 3

Connection terminals, input module UG6913.16 with 16 inputs

TERMINAL	SIGNAL	TYPE	DESCRIPTION	OPERATION
1	24VDC	-	24VDC power supply	-
2	NODE_SEL0	Input	Node selection	Input ("Type 2" according to EN 61131-2)
3	NODE_SEL1	Input		Input ("Type 2" according to EN 61131-2)
4	GND	-	0VDC power supply	-
5	INPUT1	Input	Digital input 1	Input ("Type 2" according to EN 61131-2)
6	INPUT2	Input	Digital input 2	Input ("Type 2" according to EN 61131-2)
7	INPUT3	Input	Digital input 3	Input ("Type 2" according to EN 61131-2)
8	INPUT4	Input	Digital input 4	Input ("Type 2" according to EN 61131-2)
9	OUT_TEST1	Output	Short circuit detection output	PNP active high
10	OUT_TEST2	Output	Short circuit detection output	PNP active high
11	OUT_TEST3	Output	Short circuit detection output	PNP active high
12	OUT_TEST4	Output	Short circuit detection output	PNP active high
13	INPUT5	Input	Digital input 5	Input ("Type 2" according to EN 61131-2)
14	INPUT6	Input	Digital input 6	Input ("Type 2" according to EN 61131-2)
15	INPUT7	Input	Digital input 7	Input ("Type 2" according to EN 61131-2)
16	INPUT8	Input	Digital input 8	Input ("Type 2" according to EN 61131-2)
17	INPUT9	Input	Digital input 9	Input ("Type 2" according to EN 61131-2)
18	INPUT10	Input	Digital input 10	Input ("Type 2" according to EN 61131-2)
19	INPUT11	Input	Digital input 11	Input ("Type 2" according to EN 61131-2)
20	INPUT12	Input	Digital input 12	Input ("Type 2" according to EN 61131-2)
21	INPUT13	Input	Digital input 13	Input ("Type 2" according to EN 61131-2)
22	INPUT14	Input	Digital input 14	Input ("Type 2" according to EN 61131-2)
23	INPUT15	Input	Digital input 15	Input ("Type 2" according to EN 61131-2)
24	INPUT16	Input	Digital input 16	Input ("Type 2" according to EN 61131-2)

Table 4

Connection terminals, input module UG6913.12 with 12 inputs

TERMINAL	SIGNAL	TYPE	DESCRIPTION	OPERATION
1	24VDC	-	24VDC power supply	-
2	NODE_SEL0	Input	Node selection	Input ("Type 2" according to EN 61131-2)
3	NODE_SEL1	Input		Input ("Type 2" according to EN 61131-2)
4	GND	-	0VDC power supply	-
5	INPUT1	Input	Digital input 1	Input ("Type 2" according to EN 61131-2)
6	INPUT2	Input	Digital input 2	Input ("Type 2" according to EN 61131-2)
7	INPUT3	Input	Digital input 3	Input ("Type 2" according to EN 61131-2)
8	INPUT4	Input	Digital input 4	Input ("Type 2" according to EN 61131-2)
9	OUT_TEST1	Output	Short circuit detection output	PNP active high
10	OUT_TEST2	Output	Short circuit detection output	PNP active high
11	OUT_TEST3	Output	Short circuit detection output	PNP active high
12	OUT_TEST4	Output	Short circuit detection output	PNP active high
13	INPUT5	Input	Digital input 5	Input ("Type 2" according to EN 61131-2)
14	INPUT6	Input	Digital input 6	Input ("Type 2" according to EN 61131-2)
15	INPUT7	Input	Digital input 7	Input ("Type 2" according to EN 61131-2)
16	INPUT8	Input	Digital input 8	Input ("Type 2" according to EN 61131-2)
17	OUT_TEST5	Output	Short circuit detection output	PNP active high
18	OUT_TEST6	Output	Short circuit detection output	PNP active high
19	OUT_TEST7	Output	Short circuit detection output	PNP active high
20	OUT_TEST8	Output	Short circuit detection output	PNP active high
21	INPUT9	Input	Digital input 13	Input ("Type 2" according to EN 61131-2)
22	INPUT10	Input	Digital input 14	Input ("Type 2" according to EN 61131-2)
23	INPUT11	Input	Digital input 15	Input ("Type 2" according to EN 61131-2)
24	INPUT12	Input	Digital input 16	Input ("Type 2" according to EN 61131-2)

Table 5

Connection terminals, input module UG6913.08 with 8 inputs

TERMINAL	SIGNAL	TYPE	DESCRIPTION	OPERATION
1	24VDC	-	24VDC power supply	-
2	NODE_SEL0	Input	Node selection	Input ("Type 2" according to EN 61131-2)
3	NODE_SEL1	Input		Input ("Type 2" according to EN 61131-2)
4	GND	-	0VDC power supply	-
5	INPUT1	Input	Digital input 1	Input ("Type 2" according to EN 61131-2)
6	INPUT2	Input	Digital input 2	Input ("Type 2" according to EN 61131-2)
7	INPUT3	Input	Digital input 3	Input ("Type 2" according to EN 61131-2)
8	INPUT4	Input	Digital input 4	Input ("Type 2" according to EN 61131-2)
9	OUT_TEST1	Output	Short circuit detection output	PNP active high
10	OUT_TEST2	Output	Short circuit detection output	PNP active high
11	OUT_TEST3	Output	Short circuit detection output	PNP active high
12	OUT_TEST4	Output	Short circuit detection output	PNP active high
13	INPUT5	Input	Digital input 5	Input ("Type 2" according to EN 61131-2)
14	INPUT6	Input	Digital input 6	Input ("Type 2" according to EN 61131-2)
15	INPUT7	Input	Digital input 7	Input ("Type 2" according to EN 61131-2)
16	INPUT8	Input	Digital input 8	Input ("Type 2" according to EN 61131-2)

Table 6

Connection terminals, output module OSSD UG6912.04 with 4 OSSD

TERMINAL	SIGNAL	TYPE	DESCRIPTION	OPERATION
1	24VDC	-	24VDC power supply	-
2	NODE_SEL0	Input	Node selection	Input ("Type 2" according to EN 61131-2)
3	NODE_SEL1	Input		Input ("Type 2" according to EN 61131-2)
4	GND	-	0VDC power supply	-
5	OSSD1_A	Output	Static output 1	PNP active high
6	OSSD1_B	Output		PNP active high
7	RESTART_FBK1	Input	Feedback/Restart 1	Input ("Type 2" according to EN 61131-2)
8	OUT_STATUS1	Output	Programmable digital output	PNP active high
9	OSSD2_A	Output	Static output 2	PNP active high
10	OSSD2_B	Output		PNP active high
11	RESTART_FBK2	Input	Feedback/Restart 2	Input ("Type 2" according to EN 61131-2)
12	OUT_STATUS2	Output	Programmable digital output	PNP active high
13	24VDC	-	24VDC power supply	OSSD1/2 power supply
14	24VDC	-	24VDC power supply	OSSD3/4 power supply
15	GND	-	0VDC power supply	-
16	GND	-	0VDC power supply	-
17	OSSD4_A	Output	Static output 4	PNP active high
18	OSSD4_B	Output		PNP active high
19	RESTART_FBK4	Input	Feedback/Restart 4	Input ("Type 2" according to EN 61131-2)
20	OUT_STATUS4	Output	Programmable digital output	PNP active high
21	OSSD3_A	Output	Static output 3	PNP active high
22	OSSD3_B	Output		PNP active high
23	RESTART_FBK3	Input	Feedback/Restart 3	Input ("Type 2" according to EN 61131-2)
24	OUT_STATUS3	Output	Programmable digital output	PNP active high

Table 7

Connection terminals, output module OSSD UG6912.02 with 2 OSSD

TERMINAL	SIGNAL	TYPE	DESCRIPTION	OPERATION
1	24VDC	-	24VDC power supply	-
2	NODE_SEL0	Input	Node selection	Input ("Type 2" according to EN 61131-2)
3	NODE_SEL1	Input		Input ("Type 2" according to EN 61131-2)
4	GND	-	0VDC power supply	-
5	OSSD1_A	Output	Static output 1	PNP active high
6	OSSD1_B	Output		PNP active high
7	RESTART_FBK1	Input	Feedback/Restart 1	Input ("Type 2" according to EN 61131-2)
8	OUT_STATUS1	Output	Programmable digital output	PNP active high
9	OSSD2_A	Output	Static output 2	PNP active high
10	OSSD2_B	Output		PNP active high
11	RESTART_FBK2	Input	Feedback/Restart 2	Input ("Type 2" according to EN 61131-2)
12	OUT_STATUS2	Output	Programmable digital output	PNP active high
13	24VDC	-	24VDC power supply	OSSD1/2 power supply
15	GND	-	0VDC power supply	-

Table 8

Connection terminals, output module relay UG6912.28 with 2 OSSD

TERMINAL	SIGNAL	TYPE	DESCRIPTION	OPERATION
1	FBK_A1_A2_1	Input	Feedback common for ZONE 1 and ZONE 2	-
4	GND	-	0VDC power supply	-
5	OSSD1_A	Input	Control ZONE 1	PNP active high
6	OSSD1_B	Input		
7	FBK_A1_2	Output	Feedback ZONE 1	N.C.
9	A_NC1	Output	NC contact ZONE 1	
10	B_NC1	Output		
13	A_NO11	Output	NO1 contact ZONE 1	
14	B_NO11	Output		
15	A_NO12	Output	NO2 contact ZONE 1	
16	B_NO12	Output		
11	A_NC2	Output	NC contact ZONE 2	
12	B_NC2	Output		
17	OSSD2_A	Input	Control ZONE 2	PNP active high
18	OSSD2_B	Input		
19	FBK_A2_2	Output	Feedback ZONE 2	N.C.
21	A_NO21	Output	NO1 contact ZONE 2	
22	B_NO21	Output		
23	A_NO22	Output	NO2 contact ZONE 2	
24	B_NO22	Output		

Table 9

Connection terminals, output module relay UG6912.14 with 1 OSSD

TERMINAL	SIGNAL	TYPE	DESCRIPTION	OPERATION
1	FBK_A1_1	Input	Feedback ZONE 1	-
4	GND	-	0VDC power supply	-
5	OSSD1_A	Input	Control ZONE 1	PNP active high
6	OSSD1_B	Input		
7	FBK_A1_2	Output	Feedback ZONE 1	N.C.
9	A_NC1	Output	NC contact ZONE 1	
10	B_NC1	Output		
13	A_NO11	Output	NO1 contact ZONE 1	
14	B_NO11	Output		
15	A_NO12	Output	NO2 contact ZONE 1	
16	B_NO12	Output		

Table 10

Connection terminals, output module relay UG6914.04/000

TERMINAL	SIGNAL	TYPE	DESCRIPTION	OPERATION
1	24VDC	-	24VDC power supply	-
2	NODE_SEL0	Input	Node selection	Input (" Type 2 " according to EN 61131-2)
3	NODE_SEL1	Input		Input (" Type 2 " according to EN 61131-2)
4	GND	-	0VDC power supply	-
5	REST_FBK1	Input	Feedback/Restart 1	Input (" Type 2 " according to EN 61131-2)
6	REST_FBK2	Input	Feedback/Restart 2	Input (" Type 2 " according to EN 61131-2)
7	REST_FBK3	Input	Feedback/Restart 3	Input (" Type 2 " according to EN 61131-2)
8	REST_FBK4	Input	Feedback/Restart 4	Input (" Type 2 " according to EN 61131-2)
9	A_NO1	Output	NO contact channel 1	
10	B_NO1	Output		
11	A_NO2	Output	NO contact channel 2	
12	B_NO2	Output		
13	A_NO3	Output	NO contact channel 3	
14	B_NO3	Output		
15	A_NO4	Output	NO contact channel 4	
16	B_NO4	Output		

Table 11

Connection terminals, output module relay UG6914.04/008

TERMINAL	SIGNAL	TYPE	DESCRIPTION	OPERATION
1	24VDC	-	24VDC power supply	-
2	NODE_SEL0	Input	Node selection	Input (" Type 2 " according to EN 61131-2)
3	NODE_SEL1	Input		Input (" Type 2 " according to EN 61131-2)
4	GND	-	0VDC power supply	-
5	REST_FBK1	Input	Feedback/Restart 1	Input (" Type 2 " according to EN 61131-2)
6	REST_FBK2	Input	Feedback/Restart 2	Input (" Type 2 " according to EN 61131-2)
7	REST_FBK3	Input	Feedback/Restart 3	Input (" Type 2 " according to EN 61131-2)
8	REST_FBK4	Input	Feedback/Restart 4	Input (" Type 2 " according to EN 61131-2)
9	A_NO1	Output	NO contact channel 1	
10	B_NO1	Output		
11	A_NO2	Output	NO contact channel 2	
12	B_NO2	Output		
13	A_NO3	Output	NO contact channel 3	
14	B_NO3	Output		
15	A_NO4	Output	NO contact channel 4	
16	B_NO4	Output		
17	OUT_STATUS1	Output	Programmable digital output	PNP active high
18	OUT_STATUS2	Output	Programmable digital output	PNP active high
19	OUT_STATUS3	Output	Programmable digital output	PNP active high
20	OUT_STATUS4	Output	Programmable digital output	PNP active high
21	OUT_STATUS5	Output	Programmable digital output	PNP active high
22	OUT_STATUS6	Output	Programmable digital output	PNP active high
23	OUT_STATUS7	Output	Programmable digital output	PNP active high
24	OUT_STATUS8	Output	Programmable digital output	PNP active high

Table 12

Connection terminals, Speed monitoring module UG6917

TERMINAL	SIGNAL	TYPE	DESCRIPTION	OPERATION
1	24VDC	-	24VDC power supply	-
2	NODE_SEL0	Input	Node selection	Input (" Type 2 " according to EN 61131-2)
3	NODE_SEL1	Input		Input (" Type 2 " according to EN 61131-2)
4	GND	-	0VDC power supply	-
5	PROXI1_24V	Output	PROXIMITY 1 connections	Power supply 24VDC to PROXY 1
6	PROXI1_REF	Output		Power supply 0VDC to PROXY 1
7	PROXI1 IN1 (3 WIRES)	Input		PROXY 1 NO input
8	PROXI1 IN2 (4 WIRES)	Input		PROXY 1 NC input
9	PROXI2_24V	Output	PROXIMITY 2 connections	Power supply 24VDC to PROXY 2
10	PROXI2_REF	Output		Power supply 0VDC to PROXY 2
11	PROXI2 IN1 (3 WIRES)	Input		PROXY 2 NO input
12	PROXI2 IN2 (4 WIRES)	Input		PROXY 2 NC input

Table 13

Encoder connections (RJ45) Speed monitoring module UG6917

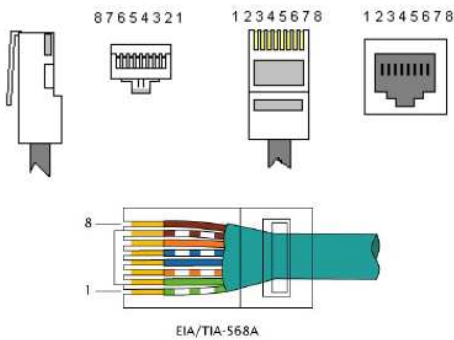

Pin	TTL UG6917/102 UG6917/112	HTL UG6917/202 UG6917/222	Sin/Cos UG6917/302 UG6917/332
1	5VDC	N.C.	N.C.
2	EXT_0V	EXT_0V	EXT_0V
3	N.C.	N.C.	N.C.
4	A	A	A
5	/A	/A	/A
6	N.C.	N.C.	N.C.
7	B	B	B
8	/B	/B	/B

Table 14

Connection terminals, BusExtender module UG6918

TERMINAL	SIGNAL	TYPE
1	+24 VDC	power supply 24VDC
2		-
3	shield CH2	-
4	0 VDC	power supply 0VDC
5		-
6		-
7	shield CH1	-
8		-
9	CH 2 - A	Be sure to connect corresponding terminals to corresponding channels of the remote UG6918: CH 1 <-> CH 1 or CH 2 <-> CH 2 A <-> A B <-> B C <-> C D <-> D Shield <-> Shield
10	CH 2 - B	
11	CH 2 - C	
12	CH 2 - D	
13	CH 1 - A	
14	CH 1 - B	
15	CH 1 - C	
16	CH 1 - D	

Table 15

EXAMPLE OF CONNECTION TO THE MACHINE CONTROL SYSTEM

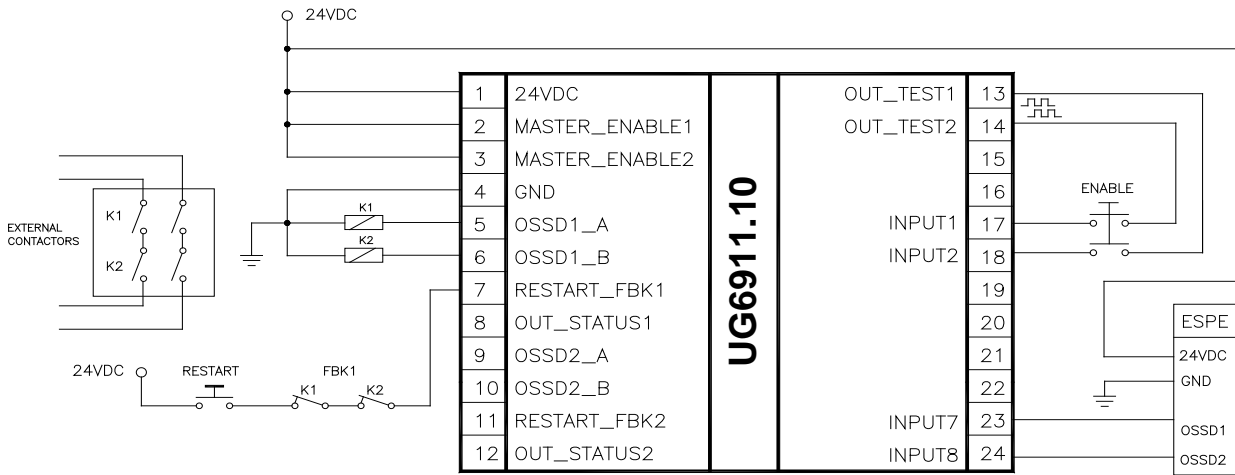





Figure 5

Calculation of safety distance of an ESPE connected to SAFEMASTER PRO

Any Electro-sensitive Protective Equipment device (ESPE) connected to SAFEMASTER PRO, must be positioned at a distance equal to or greater than the minimum safety distance **S** so that the dangerous point can be reached only after stopping the dangerous movement of the machine.

-  The european standard:
 - ISO 13855:2010- (EN 999:2008) Safety of machinery - *Positioning of safeguards with respect to the approach speeds of parts of the human body*¹ provides the elements to calculate the proper safety distance.
-  Carefully read the installation manual of each device for specific information on the correct positioning.
-  Remember that the total response time depends on:
SAFEMASTER PRO response time + ESPE response time + response time of the machine (i.e. the time taken by the machine to stop the dangerous movement from the moment in which the stop signal is transmitted).

CHECKLIST AFTER INSTALLATION

The SAFEMASTER PRO system is able to detect the faults that occurs in each own unit. Anyway to have the system perfect operation, perform the following checks at start up and at least every one year:

1. Operate a complete system TEST (see "[TESTING the system](#)")
2. Verify that all the cables are correctly inserted and the terminal blocks well screwed.
3. Verify that all the LEDs (indicators) light on correctly.
4. Verify the positioning of all the sensors connected to SAFEMASTER PRO.
5. Verify the correct fixing of SAFEMASTER PRO to the 35mm rail.
6. Verify that all the external indicators (lamps) work properly.

-  After installation, maintenance and after any eventual configuration change perform a System TEST as described in the paragraph "[TESTING the system](#)" at page 73.

¹ "Describe the methods that designers can use to calculate the minimum safety distance from a specific dangerous point for the safety devices, particularly Electro-sensitive devices (eg. light curtains), safety-mats or pressure sensitive floors and bimanual control. It contains a rule to determine the placement of safety devices based on approach speed and the stopping time of the machine, which can reasonably be extrapolated so that it also includes the interlocking guards without guard locking."

PROJECT DEVELOPMENT DIAGRAM

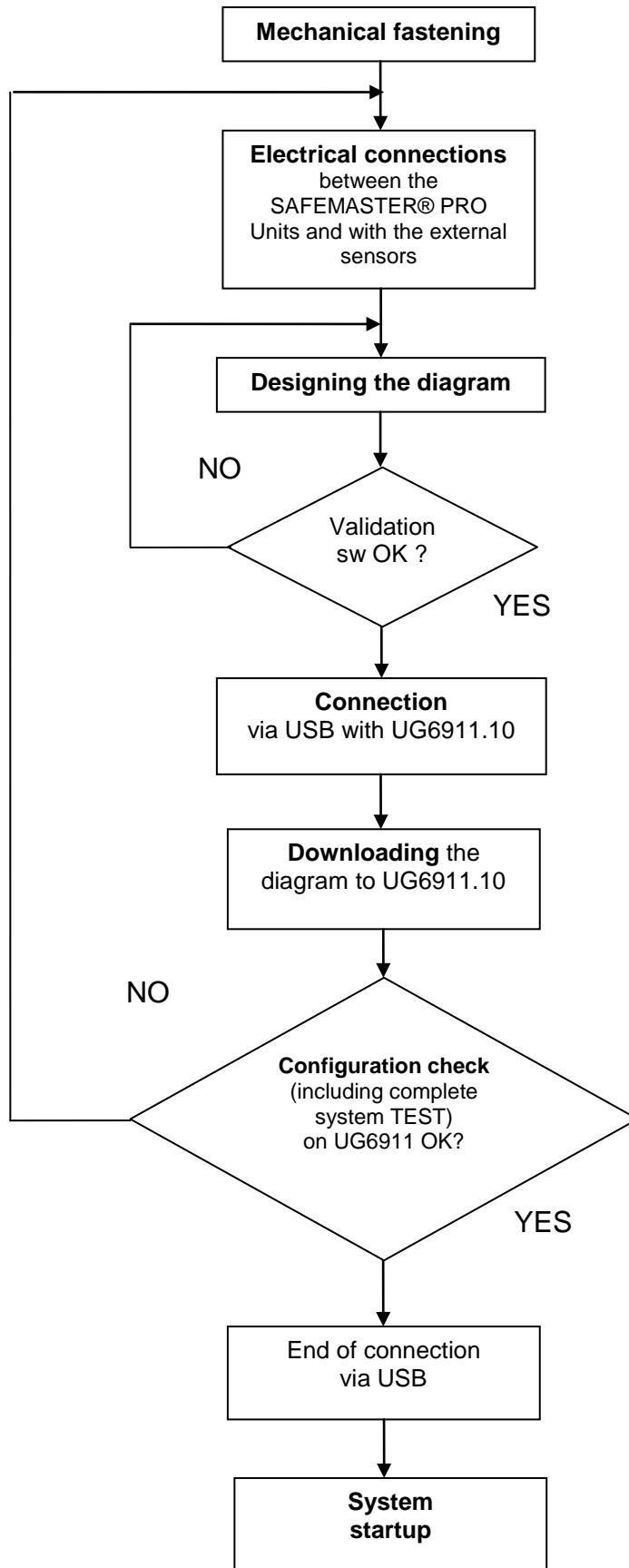

SIGNALS

INPUTS

MASTER ENABLE

The control unit UG6911.10 control unit has two inputs: MASTER_ENABLE1 and MASTER_ENABLE2.

➔ These signals must both be permanently set to logic level 1 (24VDC) for the SAFEMASTER PRO to operate. If the user needs to disable the SAFEMASTER PRO simply lower these inputs to logic level 0 (0VDC).

NODE SEL

The NODE_SEL0 and NODE_SEL1 inputs (on the expansion units) are used to attribute a physical address to the expansion units with the connections shown in Table :

	NODE_SEL0	NODE_SEL1
expansion unit 0	0 (or not connected)	0 (or not connected)
expansion unit 1	24VDC	0 (or not connected)
expansion unit 2	0 (or not connected)	24VDC
expansion unit 3	24VDC	24VDC

Table 16

➔ It is not allowed to use the same physical address on two units of the same type.

PROXIMITY INPUT FOR SPEED CONTROLLER

Configuration with Interleaved Proximity (Figure 5)

When an axis of the UG6910 module is configured for a measurement with two proximity switches, these can be configured in interleaved mode.

 Under the conditions listed below the system reaches a Performance Level = PLe:

- Proximity switches must be fitted such that the recorded signals overlap.
- Proximity switches must be fitted such that at least one is always activated.

In addition:

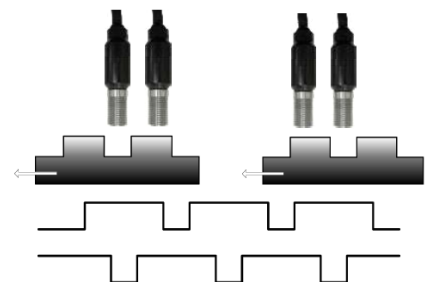

- The proximity switches must be PNP type.
- The proximity switches must be NO type (Output ON when detecting metal).
- With the above conditions fulfilled, the DC value is equal to 90%.
- The two proximity switches must be of the same model, with MTTF > 70 years.



RESTART_FBK

The RESTART_FBK signal input allows the SAFEMASTER PRO to verify an EDM (External Device Monitoring) feedback signal from the external contactors (series of contacts), and to monitor Manual/Automatic operation (See the list of possible connections in [Table](#)).

Each OSSD has a RESTART_FBK corresponding input.

-  If the application requires it, the response time of the external contactors must be verified by an additional device.
-  The RESTART command must be installed outside the danger area in a position where the danger area and the entire work area concerned are clearly visible.
-  It must not be possible to reach the RESTART control from inside the danger area.

MODE OF OPERATION	EDM	RESTART_FBK
AUTOMATIC	With K1_K2 control	
	Without K1_K2 control	
MANUAL	With K1_K2 control	
	Without K1_K2 control	

Table 17

OUTPUTS

OUT STATUS

The OUT STATUS signal is a programmable digital output that can indicate the status of:

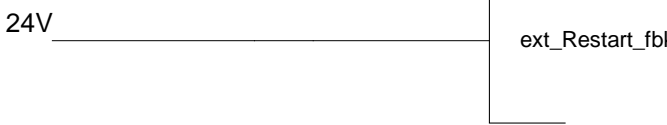
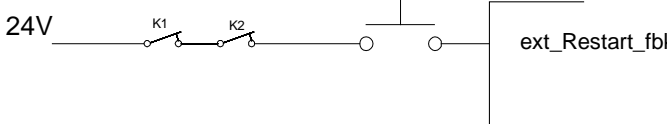
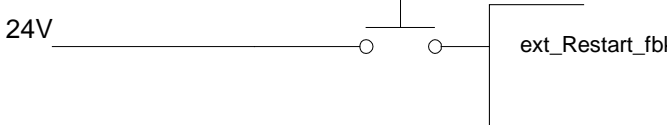
- An input.
- An output.
- A node of the logic diagram designed using the SAFEMASTER PRO DESIGNER software.

OUT TEST

The OUT TEST signals must be used to monitor the presence of short-circuits on the inputs.

SHORT CIRCUIT CONTROL

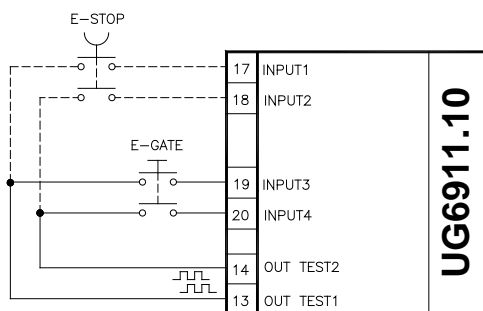

➔ The maximum number of controllable inputs for each output OUT TEST is:

- 2 INPUT (parallel connection) (UG6911.10, UG6916.10, UG6913.08, UG6913.12)
- 4 INPUT (parallel connection) (UG6913.16)

Figure 6

OSSD (control unit UG6911.10, input/output module UG6916.10)

The OSSD (*static semiconductor safety outputs*) are short circuit protected, cross circuit monitored and supply:

- In the ON condition: $U_v - 0,75V \div U_v$ (where U_v is $24V \pm 20\%$)
- In the OFF condition: $0V \div 2V$ r.m.s.

The maximum load of 400mA@24V corresponds to a minimum resistive load of 60Ω.

The maximum capacitive load is 0.82μF. The maximum inductive load is 30mH.

OSSD (output module OSSD UG6912.02, UG6912.04) with 2/4 OSSD

The OSSD (*static semiconductor safety outputs*) are short circuit protected, cross circuit monitored and supply:

- In the ON condition: $U_v - 0,75V \div U_v$ (where U_v is $24V \pm 20\%$)
- In the OFF condition: $0V \div 2V$ r.m.s.

The maximum load of 400mA@24V corresponds to a minimum resistive load of 60Ω.

The maximum capacitive load is 0.82μF. The maximum inductive load is 30mH.

➔ It is not allowed the connection of external devices to the outputs, except as expected in the configuration performed with the SAFEMASTER PRO DESIGNER software.

Each OSSD output can be configured as shown in 8:

Automatic	The output is activated according to the configurations set by the SAFEMASTER PRO DESIGNER software only if the corresponding RESTART_FBK input is connected to 24VDC.
Manual	The output is activated according to the configurations set by the SAFEMASTER PRO DESIGNER software only if corresponding RESTART_FBK input FOLLOWS A LOGIC TRANSITION OF 0-->1.
Monitored	The output is activated according to the configurations set by the SAFEMASTER PRO DESIGNER software only if the corresponding RESTART_FBK input FOLLOWS A LOGIC TRANSITION OF 0-->1-->0.

Table 18

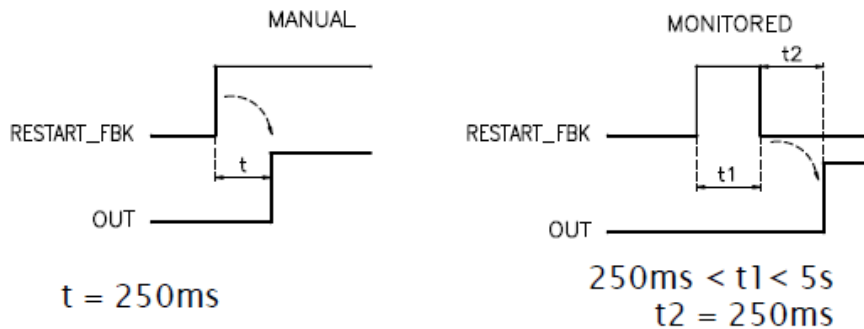

SAFETY RELAYS (output module relay UG6912.14, UG6912.28 with 1/2 OSSD)

Characteristics of the output circuit.

The 1/2 OSSD safety relay units UG6912.14/UG6912.28 use guided contact safety relays, each of which provides **two N.O. contacts and one N.C contact in addition to the N.C. feedback contact.**

The UG6912.14 unit uses two safety relays and the UG6912.28 uses four.

Excitation voltage	17...31 VDC
Minimum switchable voltage	10 VDC
Minimum switchable current	20 mA
Maximum switchable voltage (DC)	250VDC
Maximum switchable voltage (AC)	400VAC
Maximum switchable current	6A
Response time	12ms
Mechanical life of contacts	> 20 x 10⁶

Table 19

- ➔ To guarantee correct isolation and avoid the risk of premature ageing of or damage to the relays, each output line must be protected using a delay 3.5A fuse and the load characteristics must be consistent with those specified in Table 19.
- ➔ See the "[Output module relay UG6912.14 - UG6912.28](#)" section (for further details on these relays).

Internal contacts diagram

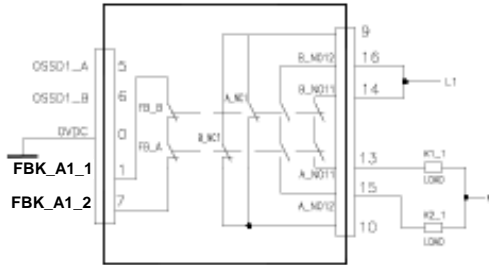

UG6912.14

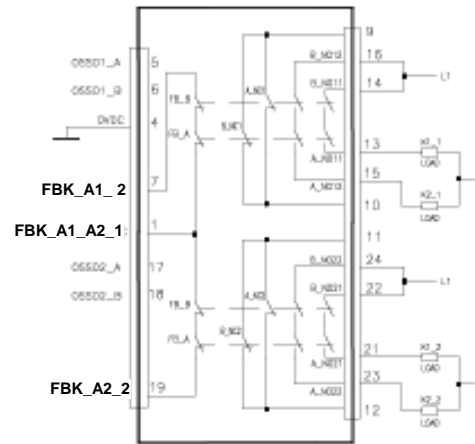

UG6912.28

Figure 7

Example: connection static OSSD outputs from control unit UG6911.10 to output module relay UG6912.14 with 1 OSSD ²⁾

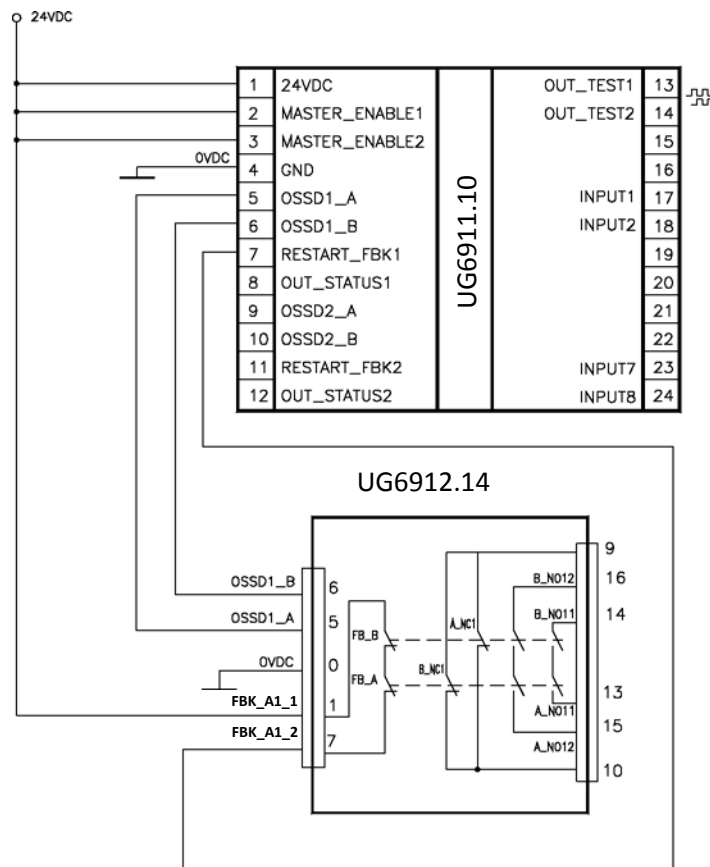

Figure 8

Switching operation timing diagram.

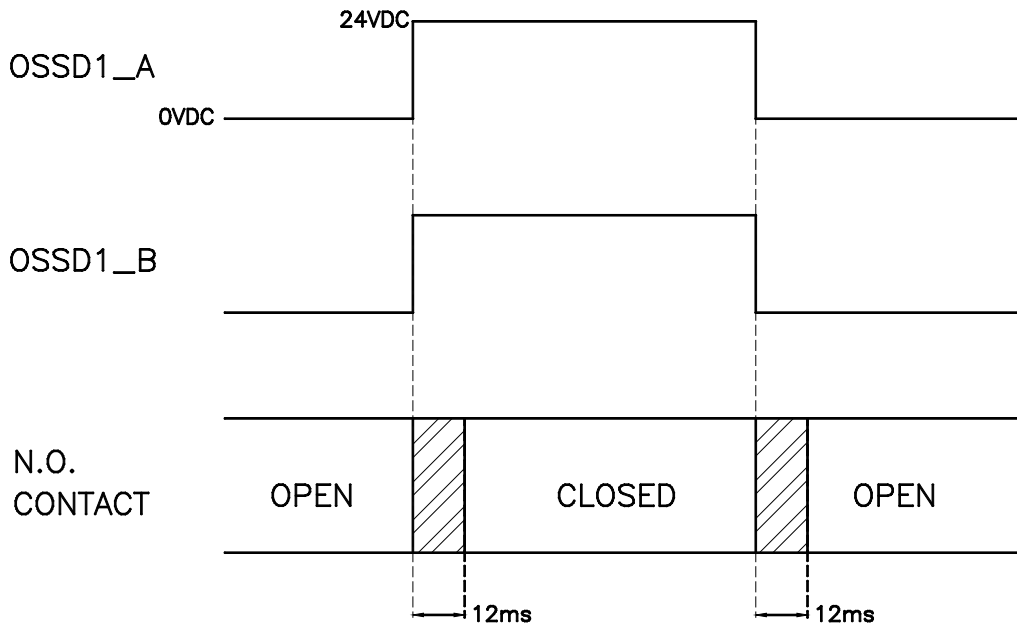

Figure 9

² If a relay unit is connected, the response time of the OSSD linked, must be increased of 12ms.

TECHNICAL FEATURES

GENERAL SYSTEM CHARACTERISTICS

Safety level parameters

Parameter	Value	Standard
PFH _d	See the technical data tables for each module	IEC 61508: 2 nd edition
SIL	3	
SILCL	3	IEC 62061:2005
Type	4	EN 61496-1
PL	e	EN ISO 13849-1:2008 IEC 62061:2005
DC _{avg}	High	
MTTF _d (years)	30 ÷ 100	
Category	4	
Device lifetime	20 years	
Pollution degree	2	

General data

Max number of inputs	128
Max number of OSSD outputs	16 dual channel outputs
Max. number of status outputs	16
Max number of slave units (excluding UG6912.14-UG6912.28)	14
Max number of slave units of the same type (excluding UG6912.14-UG6912.28)	4
Max. number of operator function blocs	64
Max. number of timer functions	16
Max. number of counter functions	16
Max. number of memory functions	16
Max. number of muting functions	4
Rated voltage	24VDC ± 20% / Remote Class 2 Source or limited voltage limited current
Digital INPUTS	"Type 2" according to EN 61131-2 I _N : 7ma to 10mA at DC24V
Digital Status OUTPUTS (UG6911.10, UG6916.10, UG6912.02, UG6912.04)	PNP active high - 100mA at 24VDC max
OSSD (UG6911.10, UG6916.10, UG6912.02, UG6912.04)	PNP active high - 400mA at 24VDC max

OSSD Response time This response times depends on the following parameters: 1) Number of Slave modules installed 2) Number of Operators 3) Number of OSSD outputs For the right response time refer to the one calculated by the SAFEMASTER PRO DESIGNER software (Project report)	control unit	10,6ms ÷ 12,6ms + T _{Filter_Input}
	UG6911.10 + 1 Slave	11,8ms ÷ 26,5ms + T _{Filter_Input}
	UG6911.10 + 2 Slaves	12,8ms ÷ 28,7ms + T _{Filter_Input}
	UG6911.10 + 3 Slaves	13,9ms ÷ 30,8ms + T _{Filter_Input}
	UG6911.10 + 4 Slaves	15ms ÷ 33ms + T _{Filter_Input}
	UG6911.10 + 5 Slaves	16ms ÷ 35ms + T _{Filter_Input}
	UG6911.10 + 6 Slaves	17ms ÷ 37,3ms + T _{Filter_Input}
	UG6911.10 + 7 Slaves	18,2ms ÷ 39,5ms + T _{Filter_Input}
	UG6911.10 + 8 Slaves	19,3ms ÷ 41,7ms + T _{Filter_Input}
	UG6911.10 + 9 Slaves	20,4ms ÷ 43,8ms + T _{Filter_Input}
	UG6911.10 + 10 Slaves	21,5ms ÷ 46ms + T _{Filter_Input}
	UG6911.10 + 11 Slaves	22,5ms ÷ 48,1ms + T _{Filter_Input}
	UG6911.10 + 12 Slaves	23,6ms ÷ 50,3ms + T _{Filter_Input}
	UG6911.10 + 13 Slaves	24,7ms ÷ 52,5ms + T _{Filter_Input}
	UG6911.10 + 14 Slaves	25,8ms ÷ 54,6ms + T _{Filter_Input}
UG6911.10 > unit connection	proprietary 5-pole DOLD IN-RAIL-BUS	
Max length of connections	100m	
Operating temperature	-10 ÷ 55°C	
Storage temperature	-20 ÷ 70°C	
Relative humidity	10% ÷ 95%	
Plug in with screw terminals max. cross section for connection:	1 x 0,25 ... 2,5 mm ² solid or stranded ferruled (isolated) or 2 x 0,25 ... 1,0 mm ² solid or stranded ferruled (isolated)	
Insulation of wires or sleeve length:	7 mm	
Wire fixing:	captive slotted screw M3	
Tightening torque:	0,5 ... 0,6 Nm	
Max length of connections	100m	
Operating temperature	-10 ÷ 55°C	
Storage temperature	-20 ÷ 70°C	
Relative humidity	10% ÷ 95%	
UL-Data	The safety functions were not evaluated by UL. Listing is accomplished according to requirements of Standard UL 508, "general use applications"	
UL hint	For use in Pollution degree 2, overvoltage category II environment only	
Max surrounding air temperature	55°C	
Wire connection	60°C / 75°C copper conductors only AWG 30÷12 (solid/stranded) Torque 5-7 lb-in	

→ T_{Input_filter} = max filtering time from among those set on project inputs (see "INPUT OBJECTS" section).

Enclosure

Description	Electronic housing max 24 pole, with locking latch mounting
Enclosure material	Polyamide
Enclosure protection class	IP 40
Terminal blocks protection class	IP 20
Fastening	Quick coupling to rail according to EN 60715
Dimensions (h x l x d)	109 x 22,5 x 120,3

Mechanical dimensions

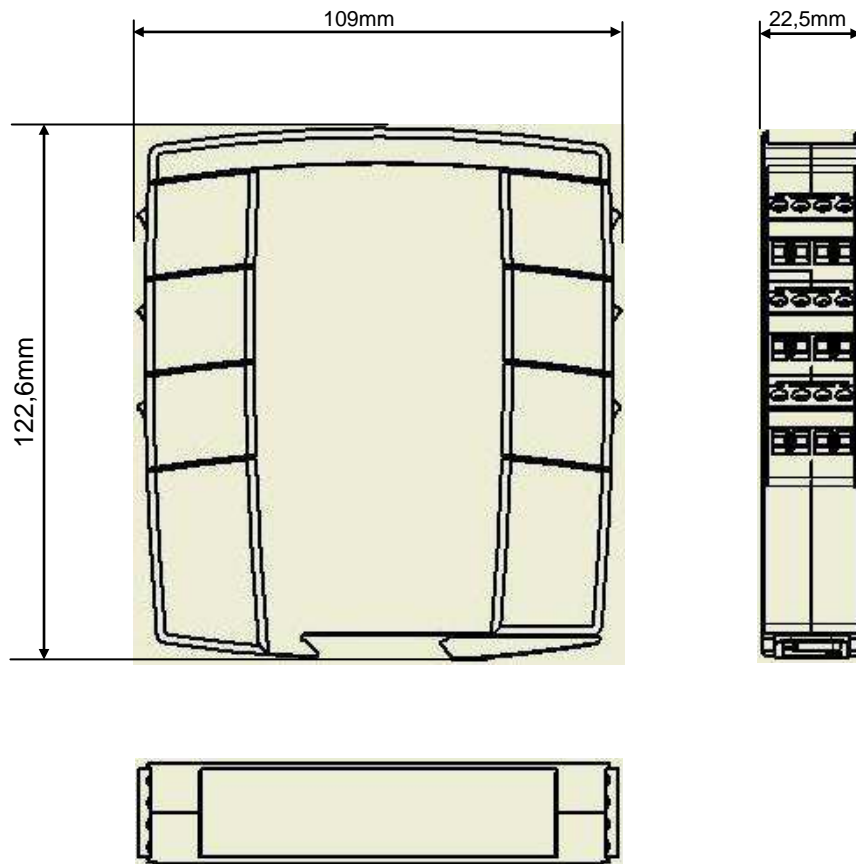





Figure 10



Control unit UG6911.10

SFF	(IEC 61508: 2 nd edition)	99,8%
PFH_d		6.86E-9
MTTF_d	EN ISO 13849-1:2008	437,63
DC_{avg}		99,0%
Nominal voltage	24VDC ± 20% / Remote Class 2 Source or limited voltage limited current	
Nominal consumption	3W max	
Inrush current	max. 10A, 0,3ms	
Unit enable inputs ENABLE (No./description)	2 / "Type 2" according to EN 61131-2 IN: 7ma to 10mA at DC24V	
Digital safety INPUTS (No./description)	8 / "Type 2" according to EN 61131-2 IN: 7ma to 10mA at DC24V	
Test OUTPUT (No./description)	4 / to check for short-circuits - overloads max. number of inputs for each output: 2	
Digital status OUTPUTS (No./description)	2 / programmable - PNP active high 100mA at 24VDC max	
OSSD (No./description)	2 pairs / solid state safety outputs PNP active high 400mA at 24VDC max	
INPUT FBK/RESTART inputs (No./description)	2 / EDM control / possible Automatic or Manual operation with RESTART button "Type 2" according to EN 61131-2, IN: 7ma to 10mA at DC24V	
SLOT for OA6911 card	Available	
Connection to PC	USB 2.0 (Hi Speed) - Max cable length: 3m	
Connection to slave units	via 5-pole IN-RAIL-BUS	
Weight	190g	
Approvals	 	

Input/output module UG6916.10 IO

SFF	(IEC 61508: 2 nd edition)	99,8%
PFH_d		5,68E-9
MTTF_d	EN ISO 13849-1:2008	458,21
DC_{avg}		99,0%
Nominal voltage	24VDC ± 20% / Remote Class 2 Source or limited voltage limited current	
Nominal consumption	3W max	
inrush current	max. 10A, 0,3ms	
Digital safety INPUTS (No./description)	8 / "Type 2" according to EN 61131-2 IN: 7ma to 10mA at DC24V	
node selection inputs NODE_SEL0/1 (No./description)	2 / "Type 2" according to EN 61131-2 IN: 7ma to 10mA at DC24V	
Test OUTPUT (No./description)	4 / to check for short-circuits - overloads max. number of inputs for each output: 2	
Digital status OUTPUTS (No./description)	2 / programmable - PNP active high 100mA at 24VDC max	
OSSD (No./description)	2 pairs / solid state safety outputs PNP active high 400mA at 24VDC max	
INPUT FBK/RESTART inputs (No./description)	2 / EDM control / possible Automatic or Manual operation with RESTART button "Type 2" according to EN 61131-2, IN: 7ma to 10mA at DC24V	
Connection to control unit UG6911.10	via 5-pole IN-RAIL-BUS	
Weight	190g	
Approvals	 	



Input modules UG6913.08 - UG6913.16 with 8 / 16 inputs

Model		UG6913.08	UG6913.16
SFF	(IEC 61508: 2 nd edition)	99,7%	99,7%
PFH _d		4,45E-9	4,94E-9
MTTF _d	EN ISO 13849-1:2008	473,00	396,47
DC _{avg}		99,0%	99,0%
Nominal voltage		24VDC ± 20% / Remote Class 2 Source or limited voltage limited current	
Nominal consumption		3W max	
Inrush current		max. 7A, 0,3ms	
Digital INPUTS (No./description)		8	16
node selection inputs NODE_SEL0/1 (No./description)		2 / "Type 2" according to EN 61131-2 IN: 7ma to 10mA at DC24V	
Test OUTPUT (No./description)		4 / to check for short-circuits - overloads max. number of inputs for each output:	
		2	4
Connection to control unit UG6911.10		via 5-pole IN-RAIL-BUS	
Weight		190g	
Approvals		 	

Input modules UG6913.13 with 12 inputs

SFF	(IEC 61508: 2 nd edition)	99,7%
PFH _d		5,56E-9
MTTF _d	EN ISO 13849-1:2008	326,05
DC _{avg}		99,0%
Nominal voltage		24VDC ± 20% / Remote Class 2 Source or limited voltage limited current
Nominal consumption		3W max
Inrush current		max. 7A, 0,3ms
Digital INPUTS (No./description)		12 / "Type 2" according to EN 61131-2 IN: 7ma to 10mA at DC24V
node selection inputs NODE_SEL0/1 (No./description)		2 / "Type 2" according to EN 61131-2 IN: 7ma to 10mA at DC24V
Test OUTPUT (No./description)		8 / to check for short-circuits - overloads max. number of inputs for each output: 2
Connection to control unit UG6911.10		via 5-pole IN-RAIL-BUS
Weight		190g
Approvals		

Output modules OSSD UG6912.02 - UG6912.04 with 2/4 OSSD

Model		UG6912.02	UG6912.04
SFF	(IEC 61508: 2 nd edition)	99,8%	99,8%
PFH _d		4,09E-9	5,84E-9
MTTF _d	EN ISO 13849-1:2008	948,88	683,38
DC _{avg}		98,9%	99%
Nominal voltage		24VDC ± 20% / Remote Class 2 Source or limited voltage limited current	
Nominal consumption		3W max	
inrush current		max. 10A, 0,3ms	
node selection inputs NODE_SEL0/1 (No./description)		2 / "Type 2" according to EN 61131-2 IN: 7ma to 10mA at DC24V	
Digital status OUTPUTS (No./description)		2	4
		programmable - PNP active high 100mA at 24VDC max	
OSSD (No./description)		2	4
		Solid state safety outputs: PNP active high 400mA at 24VDC max	
INPUT FBK/RESTART inputs (No./description)		2	2
		2 / EDM control / possible Automatic or Manual operation with RESTART button "Type 2" according to EN 61131-2, IN: 7ma to 10mA at DC24V	
Connection to control unit UG6911.10		via 5-pole IN-RAIL-BUS	
Weight		190g	
Approvals		 	

Output module relay UG6912.14 - UG6912.28 with 1/2 OSSD

PFH_d computation has been done under the following assumptions.

h_{op} in hours per day: 16

d_{op} in days per year: 220



t_{cycle1}: 300s (one commutation every 5 minutes)

t_{cycle2}: 3600s (one commutation every hour)

t_{cycle3}: 24h (one commutation every day)

Taking in account that the Relay feedback contact connection has been done as described in section EXAMPLE OF CONNECTION TO THE MACHINE CONTROL SYSTEM , every double channel connected to SAFEMASTER PRO module has the following safety values (PFH_d, SFF according to IEC61508 2nd edition, MTTF_d and DC_{avg} according to EN ISO 13849-1:2008)

PFH _d	SFF	MTTF _d	DC _{avg}		
3,09 e ⁻¹⁰	99,6%	2335,94	98,9%	t _{cycle1}	DC13 (2A)
8,53 e ⁻¹¹	99,7%	24453,47	97,7%	t _{cycle2}	
6,63 e ⁻¹¹	99,8%	126678,49	92,5%	t _{cycle3}	
8,23 e ⁻⁰⁹	99,5%	70,99	99,0%	t _{cycle1}	AC15 (3A)
7,42 e ⁻¹⁰	99,5%	848,16	99,0%	t _{cycle2}	
1,07 e ⁻¹⁰	99,7%	12653,85	98,4%	t _{cycle3}	
3,32 e ⁻⁰⁹	99,5%	177,38	99,0%	t _{cycle1}	AC15 (1A)
3,36 e ⁻¹⁰	99,6%	2105,14	98,9%	t _{cycle2}	
8,19 e ⁻¹¹	99,7%	28549,13	97,5%	t _{cycle3}	

Model	UG6912.14	UG6912.28
Nominal voltage	24VDC ± 20% / Remote Class 2 Source or limited voltage limited current	
Nominal consumption	3W max	
Switching voltage	240 VAC	
minimum switching voltage	10 VDC	
Switching current	6A max	
minimum switching current	20 mA	
Contacts	2 NO + 1 NC	4 NO + 2 NC
FEEDBACK contacts	1	2
Response time	12ms	
Mechanical life of contacts	> 20 x 10 ⁶	
B10d	AC15 230V	I = 3A: 300.000 I = 1A: 750.000
	DC13 24V	I ≤ 2A: 10.000.000
Connection to output unit	Via front-panel terminal strip (no connection via IN-RAIL-BUS)	
Inputs OSSD1_A, OSSD1_B, OSSD2_A, OSSD2_B	IN: max. 30mA at DC24V	
UL-data contact rating	each relay output: 250V, 6A, resistive	
weight	180g	230g
Approvals	 	

Output module relay UG6914.04/000 - UG6914.04/008

Model		UG6914.04/000	UG6912. 04/008
SFF	IEC 61508: 2 nd edition	99,9%	99,9%
PFH _d		2,90E-9	2,94E-9
DC _{avg}	EN ISO 13849-1:2008	99,0%	98,9%
MTTF _d		998,56	980,78
Nominal voltage		24VDC ± 20% / Remote Class 2 Source or limited voltage limited current	
Nominal consumption		max. 3 W	
Switching voltage		240 VAC	
minimum switching voltage		10 VDC	
Switching current		max. 6A	
minimum switching current		20 mA	
Contacts		4 independent NO	
INPUT FBK/RESTART (No./description)		4 / EDM control / possible Automatic or Manual operation with RESTART button Input "Type 2" according to EN 61131-2 IN: 7ma to 10mA at DC24V	
Response time		OSSD Response time (UG6911, UG6912, UG6916) + 12ms	
Mechanical life of contacts		> 20 x 10 ⁶	
B10d	AC15 230V	I = 3A: 300.000 I = 1A: 750.000	
	DC13 24V	I ≤ 2A: 10.000.000	
Digital status OUTPUTS (No./description)		0	8
Connection to control unit UG6911.10		via 5-pole IN-RAIL-BUS	
UL-data contact rating		each relay output: 250V, 6A, resistive	
weight		250g	250g
Approvals			

NOTE:

For each Relay output must be added to the previous PFH_d a value that depends on the load of the relay and its switching frequency. In addition, the PL obtained from the Relay outputs changes depending on the configuration chosen by the user. We assume N_{op} defines the number of commutations/year.

Relay Category 1

PL maximum obtainable: c
Maximum achievable SIL: 1

PFH _d	Conditions
$PFH_d = \frac{N_{op}}{2.63E10}$	AC15 Load 3A@230V _{ac}
$PFH_d = \frac{N_{op}}{6.57E10}$	AC15 Load 1A@230V _{ac}
$PFH_d = \frac{N_{op}}{8.77E11}$	DC13 Load 2A@24V _{dc}

Relay Category 2

PL maximum obtainable: d
Maximum achievable SIL: 2

PFH _d	Conditions
$PFH_d = \frac{N_{op}}{2.63E11}$	AC15 Load 3A@230V _{ac}
$PFH_d = \frac{N_{op}}{6.57E11}$	AC15 Load 1A@230V _{ac}
$PFH_d = \frac{N_{op}}{8.77E12}$	DC13 Load 2A@24V _{dc}

Relay Category 4

PL maximum obtainable: e
Maximum achievable SIL: 3

PFH _d	Conditions
$PFH_d = \frac{N_{op}}{6.62E11} + \frac{N_{op}^2}{3.92E19}$	AC15 Load 3A@230V _{ac}
$PFH_d = \frac{N_{op}}{1.65E12} + \frac{N_{op}^2}{2.45E20}$	AC15 Load 1A@230V _{ac}
$PFH_d = \frac{N_{op}}{2.22E13} + \frac{N_{op}^2}{4.36E22}$	DC13 Load 2A@24V _{dc}

MTTF_d for all relay outputs (MTTF_{dTOT})

For each Relay output the previous MTTF_d must be added to a value that depends on the load of the relay and its switching frequency according to the following formula:

$$MTTF_{dTOT} = \frac{1}{(1/MTTF_d) + (1/MTTF_{d1})}$$

MTTF _{d1} (years)	Conditions
$MTTF_{d1} = \frac{3.0E6}{N_{op}}$	AC15 Load 3A@230V _{ac}
$MTTF_{d1} = \frac{7.5E6}{N_{op}}$	AC15 Load 1A@230V _{ac}
$MTTF_{d1} = \frac{1.0E8}{N_{op}}$	DC13 Load 2A@24V _{dc}

PFH_d and MTTF_d computation under the following assumptions.

- h_{op} in hours per day: 16
- d_{op} in days per year: 220
- t_{cycle1}: 300s (one commutation every 5 minutes)
- t_{cycle2}: 3600s (one commutation every hour)
- t_{cycle3}: 24h (one commutation every day)

UG6914.04/000				
AC15 3A@230Vac				
PFH _d				
Rel. Kat. 1	Rel. Kat. 2	Rel. Kat. 4	MTTF _d	
1,61E-06	1,64E-07	6,68E-08	66,31	Zyklus 1
1,37E-07	1,63E-08	8,22E-09	459,82	Zyklus 2
1,13E-08	3,74E-09	3,23E-09	930,43	Zyklus 3
AC15 1A@230Vac				
PFH _d				
Rel. Kat. 1	Rel. Kat. 2	Rel. Kat. 4	MTTF _d	
6,46E-07	6,72E-08	2,85E-08	150,75	Zyklus 1
5,65E-08	8,26E-09	5,03E-09	679,91	Zyklus 2
6,25E-09	3,23E-09	3,03E-09	970,14	Zyklus 3
DC13 2A@230Vac				
PFH _d				
Rel. Kat. 1	Rel. Kat. 2	Rel. Kat. 4	MTTF _d	
5,11E-08	7,72E-09	4,80E-09	702,33	Zyklus 1
6,91E-09	3,31E-09	3,01E-09	964,65	Zyklus 2
3,15E-09	2,93E-09	2,91E-09	996,37	Zyklus 3

UG6914.04/008				
AC15 3A@230Vac				
PFH _d				
Rel. Kat. 1	Rel. Kat. 2	Rel. Kat. 4	MTTF _d	
1,61E-06	1,64E-07	6,68E-08	66,23	Zyklus 1
1,37E-07	1,63E-08	8,26E-09	456,01	Zyklus 2
1,13E-08	3,78E-09	3,27E-09	914,97	Zyklus 3
AC15 1A@230Vac				
PFH _d				
Rel. Kat. 1	Rel. Kat. 2	Rel. Kat. 4	MTTF _d	
6,46E-07	6,72E-08	2,85E-08	150,34	Zyklus 1
5,65E-08	8,30E-09	5,07E-09	671,62	Zyklus 2
6,29E-09	3,27E-09	3,07E-09	953,35	Zyklus 3
DC13 2A@230Vac				
PFH _d				
Rel. Kat. 1	Rel. Kat. 2	Rel. Kat. 4	MTTF _d	
5,11E-08	7,76E-09	4,84E-09	693,48	Zyklus 1
6,95E-09	3,34E-09	3,10E-09	948,05	Zyklus 2
3,19E-09	2,97E-09	2,95E-09	978,67	Zyklus 3

Speed monitoring module UG6917

Modell		UG6917/002	UG6917/102	UG6917/112	UG6917/202	UG6917/222	UG6917/302	UG6917/332
SFF	(IEC 61508: 2 nd edition)	99,7%	99,7%	99,7%	99,7%	99,7%	99,7%	99,7%
PFH _d		5,98E-9	7,08E-9	8,18E-9	6,70E-9	7,42E-9	7,93E-9	9,89E-9
MTTF _d	EN ISO 13849-1: 2008	500,33	337,72	254,88	380,05	306,40	269,49	184,41
DC _{avg}		99,0%	99,0%	99,0%	99,0%	99,0%	99,0%	99,0%

Model	UG6917/002	UG6917/x02	UG6917/xx2
Nominal voltage	24VDC ± 20% / Remote Class 2 Source or limited voltage limited current		
Nominal consumption	max. 3 W		
Max number of axis	2		
Encoder interface	-	TTL (models /102 /112) HTL (models /202 /222) sin/cos (models /302 /332)	
Encoder input signals electrically insulated in accordance with EN 61800-5	Rated insulation voltage 250V Overvoltage category II Rated impulse withstand voltage 4.00 kV		
Max number of encoders	0	1	2
Max encoder frequency	-	500KHz (HTL: 300KHz)	
Encoder connections	-	RJ45	
Max number of proximity	2		
Max proximity frequency	5KHz		
Proximity connections	Terminal blocks		
Proximity type	NP/NPN - 3/4 cables		
Connection to control unit UG6911.10	via 5-pole IN-RAIL-BUS		
weight	200g	200g	
Approvals			

BusExtender module UG6918

Nominal voltage	24VDC \pm 20% / Remote Class 2 Source or limited voltage limited current
Nominal consumption	3W max
inrush current	max. 10A, 0,3ms
Connections	5-pole IN-RAIL-BUS - 4-pole Terminal blocks
Maximum distance between 2 module UG6918	<50m (each section)
maximum number of sections	6
fieldbus module	The possible fieldbus module present in the system can only be placed to control unit UG6911.10
weight	180g
Approvals	

Cable for BusExtender Module UG6918

Maximum length	<50m
Conductors	2 twisted pairs of conductors with shield
NOMINAL IMPEDANCE	120 Ω
NOMINAL CAPACITANCE	< 42 pf/m
NOMINAL RESISTANCE	<95 m Ω /m

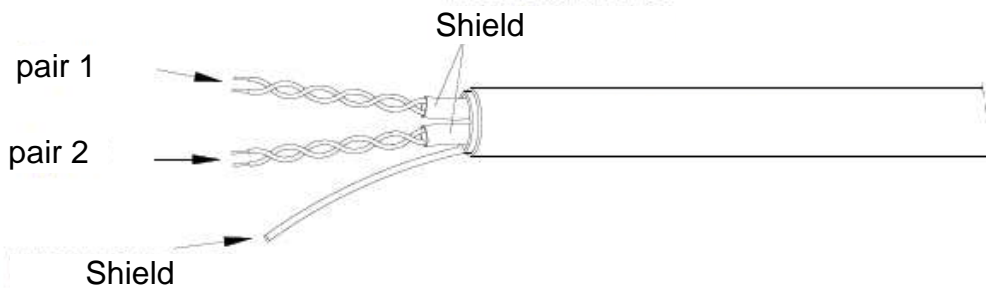

VISUALISATIONS

Control unit UG6911.10

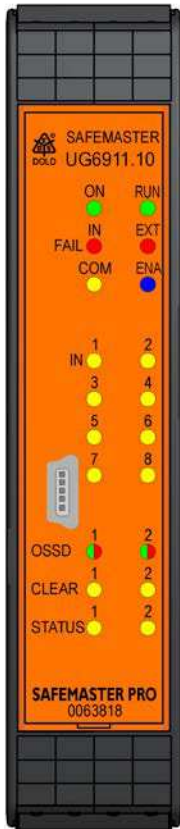

Figure 11 - UG6911.10

MEANING	LED								
	RUN GREEN	IN FAIL RED	EXT FAIL RED	COM ORANGE	ENA BLUE	IN1÷8 YELLOW	OSSD1/2 RED/GREEN	CLEAR1/2 YELLOW	STATUS1/2 YELLOW
Power on - initial TEST	ON	ON	ON	ON	ON	ON	Red	ON	ON
OA6911 recognized	OFF	OFF	OFF	ON (max 1s)	ON (max 1s)	OFF	Red	OFF	OFF
Writing / Loading diagram to / from OA6911 card	OFF	OFF	OFF	5 flashes	5 flashes	OFF	Red	OFF	OFF
SAFEMASTER PRO error: internal configuration not present	OFF	OFF	OFF	Flashes slowly	OFF	OFF	Red	OFF	OFF
SAFEMASTER PRO error: Slave module or node number not correct (ref. System composition)	OFF	OFF	OFF	Flashes quickly	OFF	OFF	Red	OFF	OFF
SAFEMASTER PRO error: slave module missing or not ready (ref. System composition)	12 Flashes quickly	OFF	OFF	12 Flashes quickly	OFF	OFF	Red	OFF	OFF
SAFEMASTER PRO DESIGNER connected, control unit UG6911 stopped	OFF	OFF	OFF	ON	OFF	OFF	Red	OFF	OFF

Table 20 - Opening Screen

MEANING	LED								
	RUN GREEN	IN FAIL RED	EXT FAIL RED	COM ORANGE	IN1÷8 YELLOW	ENA BLUE	OSSD1/2 RED/GREEN	CLEAR1/2 YELLOW	STATUS1/2 YELLOW
NORMAL OPERATION	ON	OFF	OFF op. OK	ON = UG6911 connected to PC OFF=otherwise	INPUT condition	ON MASTER_ENABLE 1 and MASTER_ENABLE 2 active OFF otherwise	RED with output OFF GREEN with output ON	ON waiting for RESTART Flashing NO feedback	OUTPUT condition
EXTERNAL FAULT DETECTED	ON	OFF	ON incorrect external connection detected	ON = UG6911 connected to PC OFF=otherwise	only the number of the INPUT with the incorrect connection flashes				

Table 21 - Dynamic Screen

Input/output module UG6916.10



MEANING	LED							
	RUN GREEN	IN FAIL RED	EXT FAIL RED	SEL ORANGE	IN1÷8 YELLOW	OSSD1/2 RED/GREEN	CLEAR1/2 YELLOW	STATUS1/2 YELLOW
Power on - initial TEST	ON	ON	ON	ON	ON	Red	ON	ON

Table 22 - Opening Screen

MEANING	LED							
	RUN GREEN	IN FAIL RED	EXT FAIL RED	IN1÷8 YELLOW	SEL ORANGE	OSSD1/2 RED/GREEN	CLEAR1/2 YELLOW	STATUS1/2 YELLOW
NORMAL OPERATION	OFF if the unit is waiting for the first communication from the CONTROL UNIT FLASHES if no INPUT or OUTPUT requested by the configuration ON if INPUT or OUTPUT requested by the configuration	OFF	OFF	INPUT condition	Shows the signals NODE_SEL0/1	RED with output OFF	ON waiting for RESTART	OUTPUT condition
			ON incorrect external connection detected	only the number of the INPUT with the incorrect connection flashes		GREEN with output ON	Flashes NO feedback	

Table 23 - Dynamic Screen

Figure 12 - UG6916.10

Input modules UG6913.08, UG6913.12, UG6913.16, with 8, 12 and 16 inputs

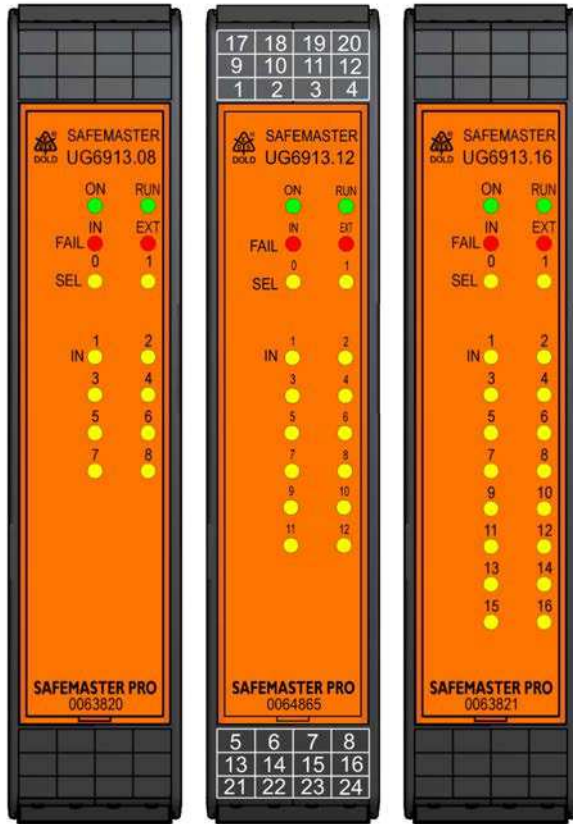

Figure 13 - UG6913.08, UG6913.12, UG6913.16

MEANING	LED				
	RUN GREEN	IN FAIL RED	EXT FAIL RED	SEL ORANGE	IN1÷16 YELLOW
Power on - initial TEST	ON	ON	ON	ON	ON

Table 24 - Opening Screen

MEANING	LED				
	RUN GREEN	IN FAIL RED	EXT FAIL RED	SEL ORANGE	IN1÷8 YELLOW
NORMAL OPERATION	OFF if the unit is waiting for the first communication from the CONTROL UNIT	OFF	OFF	Shows the signals NODE_SEL0/1	INPUT condition
	FLASHES if no INPUT or OUTPUT requested by the configuration		ON incorrect external connection detected		only the number of the INPUT with the incorrect connection flashes
	ON if INPUT or OUTPUT requested by the configuration				

Table 25 - Dynamic Screen

Output module UG6912.02, UG6912.04, with 2 or 4 OSSD

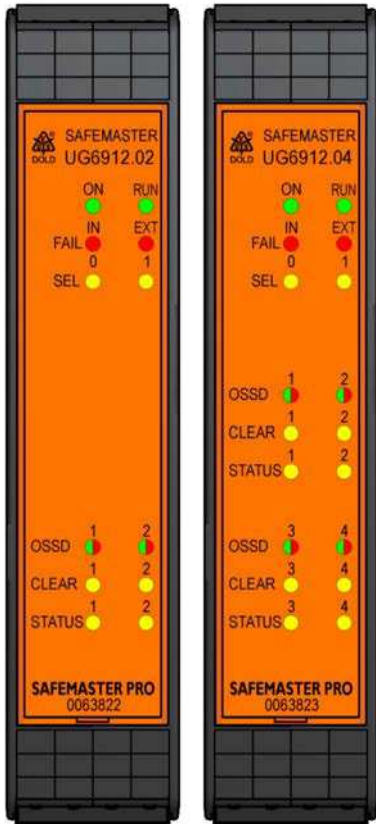

MEANING	LED						
	RUN GREEN	IN FAIL RED	EXT FAIL RED	SEL ORANGE	OSDD1/2 RED/GREEN	CLEAR1/2 YELLOW	STATUS1/2 YELLOW
Power on - initial TEST	ON	ON	ON	ON	Red	ON	ON

Table 26 - Opening screen

MEANING	LED						
	RUN GREEN	IN FAIL RED	EXT FAIL RED	SEL ORANGE	OSDD1/2 RED/GREEN	CLEAR1/2 YELLOW	STATUS1/2 YELLOW
NORMAL OPERATION	OFF if the unit is waiting for the first communication from the CONTROL UNIT	OFF op. OK	OFF op. OK	Shows the signals NODE_SEL0/1	RED with output OFF	ON waiting for RESTART	OUTPUT condition
	FLASHES if no INPUT or OUTPUT requested by the configuration				GREEN with output ON	Flashes NO feedback	
ON if INPUT or OUTPUT requested by the configuration							

Table 27 - Dynamic screen

Figure 14 - UG6912.02, UG6912.04

Output module relay UG6912.14/ UG6912.28 with 1/2 OSSD



Figure 15 - UG6912.14



Figure 16 - UG6912.28

MEANING	LED	
	OSSD1 GREEN	
NORMAL OPERATION	GREEN with output activated	

Table 28 - UG6912.14 - Dynamic screen

MEANING	LED	
	OSSD1 GREEN	OSSD2 GREEN
NORMAL OPERATION	GREEN with output activated	

Table 29 - UG6912.28 - Dynamic screen

Output module relay UG6914.04/000, UG6914.04/008

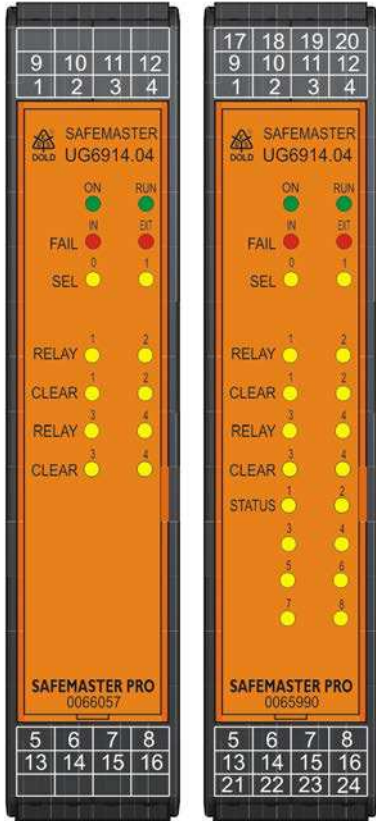

Figure 17
UG6914.04/000, UG6914.04/008

MEANING	LED						
	RUN GREEN	IN FAIL RED	EXT FAIL RED	SEL 0/1 ORANGE	RELAY 1÷4 RED/GREEN	CLEAR 1÷4 YELLOW	STATUS 1÷4 (UG6914.04/008) YELLOW
Power on - initial TEST	ON	ON	ON	ON	Rot	ON	ON

Table 30 - Opening screen

MEANING	LED						
	RUN GREEN	IN FAIL RED	EXT FAIL RED	SEL 0/1 ORANGE	RELAY 1÷4 RED/GREEN	CLEAR 1÷4 YELLOW	STATUS 1÷4 (UG6914.04/008) YELLOW
NORMAL OPERATION	<p>OFF if the unit is waiting for the first communication from the MASTER</p> <p>FLASHES if no INPUT or OUTPUT requested by the configuration</p> <p>ON if INPUT or OUTPUT requested by the configuration</p>	<p>OFF Function OK</p>	<p>OFF Function OK</p>	<p>Shows the signals NODE_SEL 0/1</p>	<p>RED with contact opened</p> <p>GREEN with contact closed</p>	<p>ON waiting for RESTART</p> <p>FLASHES External contactors feedback error</p>	<p>State of OUT-STATUS</p>

Table 31 - Dynamic screen

Speed monitoring module UG6917/002, UG6917/x02, UG6917/xx2

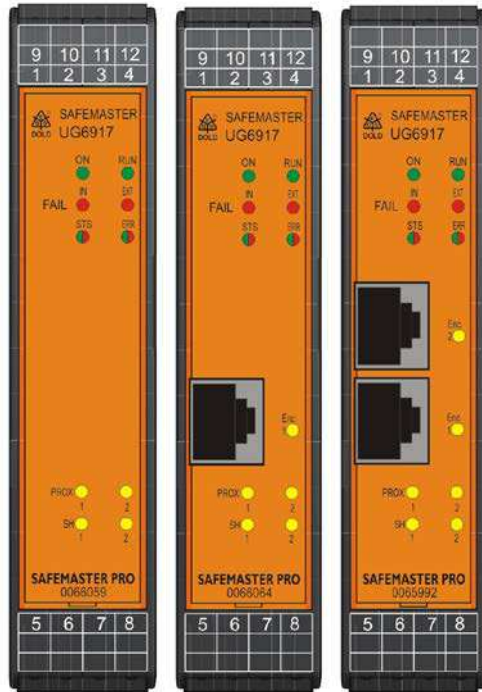

Figure 18
UG6917/002, UG6917/x02, UG6917/xx2

MEANING	LED						
	RUN GREEN	IN FAIL RED	EXT FAIL RED	SEL 0/1 ORANGE	ENC *1 YELLOW	PROX YELLOW	SH YELLOW
Power on - initial TEST	ON	ON	ON	ON	ON	ON	ON

Table 32 - Opening screen

MEANING	LED						
	RUN GREEN	IN FAIL RED	EXT FAIL RED	SEL 0/1 ORANGE	ENC *1 YELLOW	PROX YELLOW	SH YELLOW
NORMAL OPERATION	OFF if the unit is waiting for the first communication from the MASTER				ON Encoder connected and operative		OFF Axis in normal speed range
	FLASHES if no INPUT or OUTPUT requested by the configuration	OFF Function OK	OFF Function OK	Shows the signals NODE_SE L 0/1	FLASHES Encoder requested by the configuration but not connected	ON Proximity connected and operative	FLASHES Axis in overspeed
	ON if INPUT or OUTPUT requested by the configuration						ON Axis in stand still

Table 33 - Dynamic screen

*1) LED ENC not present on UG6917/002

BusExtender module UG6918



Figure 19 UG6918

MEANING	LED			
	ON (GREEN)	RUN (GREEN)	IN FAIL (RED)	EXT FAIL (RED)
INITIAL TEST	ON	ON	ON	ON
NORMAL OPERATION	ON	OFF > BLINKING > ON	OFF Operation OK	OFF Operation OK

Table 34 - UG6918 - Dynamic screen

TROUBLESHOOTING

Control unit UG6911.10

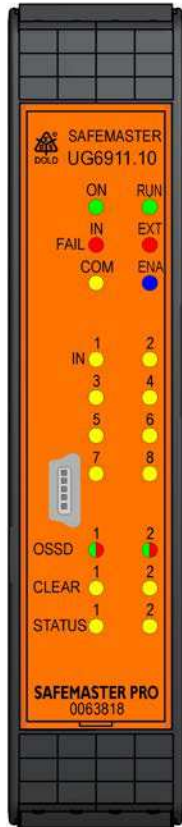
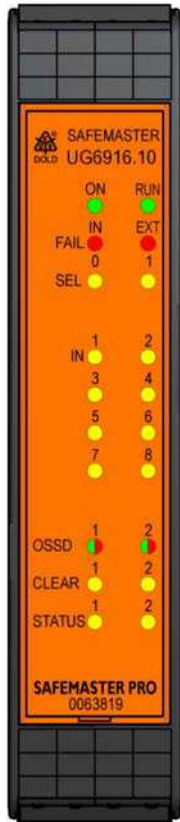

Figure 20 - UG6911.10

MEANING	LED									REMEDY
	RUN GREEN	IN FAIL RED	EXT FAIL RED	COM ORANGE	IN1÷8 YELLOW	ENA BLUE	OSSD1/2 RED/GREEN	CLEAR1/2 YELLOW	STATUS1/2 YELLOW	
Internal fault	OFF	2 or 3 flashes	OFF	OFF	OFF	OFF	Red	OFF	OFF	Return the unit to DOLD to be repaired
OSSD output error	OFF	4 flashes	OFF	OFF	OFF	OFF	4 flashes (only the LED corresponding to the output in FAIL mode)	OFF	OFF	<ul style="list-style-type: none"> Check the OSSD1/2 connections If the problem persists return the UG6911 to DOLD to be repaired
Error in communication with expansion units	OFF	5 flashes	OFF	OFF	OFF	OFF	OFF	OFF	OFF	<ul style="list-style-type: none"> Restart the system. If the problem persists return the UG6911 to DOLD to be repaired
expansion unit error	OFF	ON	OFF	OFF	OFF	OFF	OFF	OFF	OFF	<ul style="list-style-type: none"> Restart the system Check which unit is in FAIL mode
memory chip OA6911 error	OFF	6 flashes	OFF	6 flashes	OFF	OFF	OFF	OFF	OFF	Replace the OA6911
IN-RAIL-BUS Error	12	OFF	OFF	12	OFF	OFF	Red	OFF	OFF	<ul style="list-style-type: none"> Contact from Control unit or extension unit to IN-RAIL-BUS not correct (ref. System composition)

Table 35 - Troubleshooting UG6911

Input/output module UG6916.10



MEANING	LED								REMEDY
	RUN	IN FAIL	EXT FAIL	SEL	IN1÷8	OSSD1/2	CLEAR1/2	STATUS1/2	
	GREEN	RED	RED	ORANGE	YELLOW	RED/GREEN	YELLOW	YELLOW	
Internal fault	OFF	2 or 3 flashes	OFF	Shows the physical address of the unit	OFF	Red	OFF	OFF	Return the unit to DOLD to be repaired
Compatibility error	OFF	5 flashes	OFF		5 flashes	5 flashes	5 flashes	5 flashes	<ul style="list-style-type: none"> Firmware version not compatible with UG6911, return to DOLD for FW upgrade.
OSSD output error	OFF	4 flashes	OFF		OFF	4 flashes (only the LED corresponding to the output in FAIL mode)	OFF	OFF	<ul style="list-style-type: none"> Check OSSD1/2 connections If the problem persists, return the UG6916.10 to DOLD to be repaired
Error in communication with control unit	OFF	5 flashes	OFF		OFF	OFF	OFF	OFF	<ul style="list-style-type: none"> Restart the system If the problem persists, return the UG6916.10 to DOLD to be repaired
Error on other unit	OFF	ON	OFF		OFF	OFF	OFF	OFF	<ul style="list-style-type: none"> Restart the system Check which unit is in FAIL mode
Same type of expansion unit with same address detected	OFF	5 flashes	5 flashes		OFF	OFF	OFF	OFF	<ul style="list-style-type: none"> Change the unit's address (see NODE SEL)
Node detection circuit error	OFF	3 flashes	OFF		3 flashes	OFF	OFF	OFF	OFF

Table 36 - Troubleshooting UG6916.10

Figure 21 - UG6916.10

Input module UG6913.08, UG6913.12, UG6913.16 with 8, 12 or 16 inputs

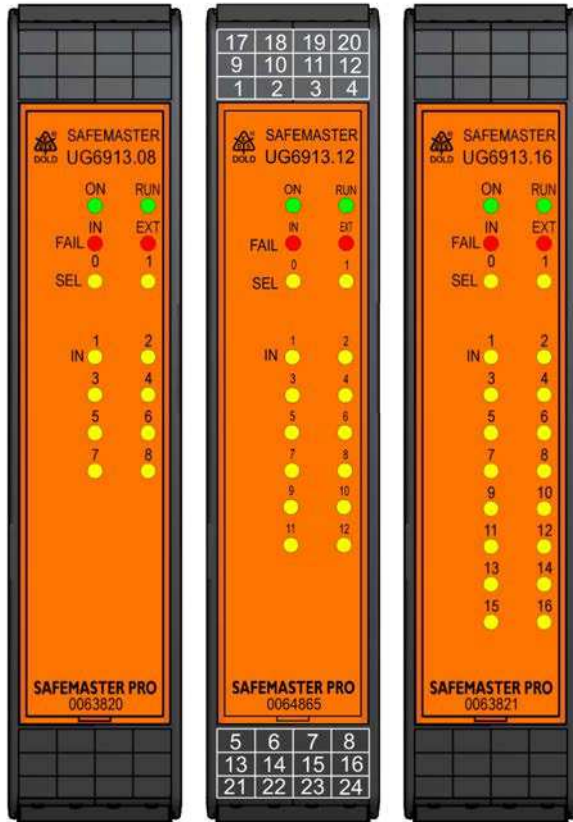

Figure 22 - UG6913.08, UG6913.12, UG6913.16

MEANING	LED					REMEDY
	RUN	IN FAIL	EXT FAIL	SEL	IN1÷16	
	GREEN	RED	RED	ORANGE	YELLOW	
Internal fault	OFF	2 or 3 flashes	OFF	Shows the physical address of the unit	OFF	Return the unit to DOLD to be repaired
Compatibility error	OFF	5 flashes	OFF		5 flashes	<ul style="list-style-type: none"> Firmware version not compatible with UG6911, return to DOLD for FW upgrade.
Error in communication with control unit	OFF	5 flashes	OFF		OFF	<ul style="list-style-type: none"> Restart the system If the problem persists, return the UG6913.08 to DOLD to be repaired
Error on other unit	OFF	ON	OFF		OFF	<ul style="list-style-type: none"> Restart the system Check which unit is in FAIL mode
Same type of expansion unit with same address detected	OFF	5 flashes	5 flashes		OFF	<ul style="list-style-type: none"> Change the unit's address (see NODE SEL)
Node detection circuit error	OFF	3 flashes	OFF		3 flashes	OFF

Table 37 - Troubleshooting UG6913.08

Output modules UG6912.02 / UG6912.04 with 2/4 OSSD

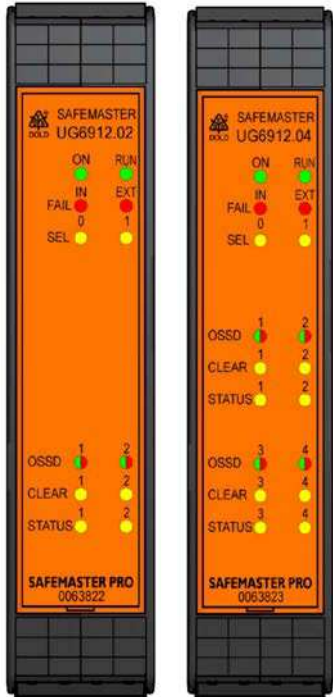

Figure 23 - UG6912.02 / UG6912.04

MEANING	LED							REMEDY	
	RUN	IN FAIL	EXT FAIL	SEL	OSSD1/4	CLEAR1/4	STATUS1/4		
	GREEN	RED	RED	ORANGE	RED/GREEN	YELLOW	YELLOW		
Internal fault	OFF	2 or 3 flashes	OFF	Shows the physical address of the unit	Red	OFF	OFF	Return the unit to DOLD to be repaired	
Compatibility error	OFF	5 flashes	OFF		5 flashes	5 flashes	5 flashes	<ul style="list-style-type: none"> Firmware version not compatible with UG6911, return to DOLD for FW upgrade. 	
OSSD output error	OFF	4 flashes	OFF		4 flashes (only the LED corresponding to the output in FAIL mode)	OFF	OFF	<ul style="list-style-type: none"> Check OSSD1/2 connections If the problem persists, return the UG6912.02/4 to DOLD to be repaired 	
Error in communication with control unit	OFF	5 flashes	OFF		OFF	OFF	OFF	<ul style="list-style-type: none"> Restart the system If the problem persists, return the UG6912.02/4 to DOLD to be repaired 	
Error on other unit	OFF	ON	OFF		OFF	OFF	OFF	<ul style="list-style-type: none"> Restart the system Check which unit is in FAIL mode 	
Same type of expansion unit with same address detected	OFF	5 flashes	5 flashes		OFF	OFF	OFF	<ul style="list-style-type: none"> Change the unit's address (see NODE SEL) 	
Power supply missing on OSSD 3,4 (UG6912.04 only)	ON	OFF	ON		ROT flashes	flashes	OUTPUT condition	<ul style="list-style-type: none"> Connect 13 and 14 pin to power supply 	
Status output overload or short circuit	ON	OFF	ON		OSSD output state	OSSD CLEAR state	flashes	<ul style="list-style-type: none"> Verify connections at 8, 12, 20, 24 	
Error on node detection circuit	OFF	3 flashes	OFF		3 flashes	OFF	OFF	OFF	<ul style="list-style-type: none"> Return the unit to DOLD to be repaired

Table 38 - Troubleshooting UG6912.02/UG6912.04

Output module relay UG6914.04/000, UG6914.04/008

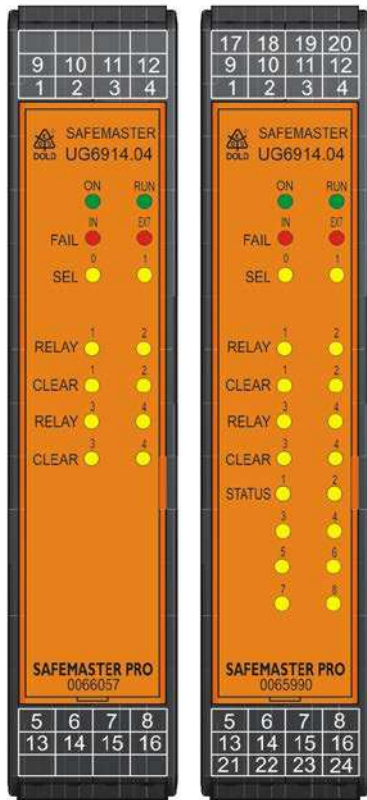

Figure 24

UG6914.04/000, UG6914.04/008

MEANING	LED (number x = number of flash)							REMEDY
	RUN	IN FAIL	EXT FAIL	SEL	RELAY 1/4	CLEAR 1/4	STATUS 1/8	
	GREEN	RED	RED	ORANGE	RED/GREEN	YELLOW	YELLOW	
Internal fault	OFF	2 or 3	OFF	Shows the physical address of the unit	Rot	OFF	OFF	Return the unit to DOLD to be repaired
Compatibility error	OFF	5	OFF		5	5	5	Firmware version not compatible with UIG6911.10, return to DOLD for FW upgrade.
Relays output error	OFF	4	OFF		4 (only the LED corresponding to the output in FAIL mode)	OFF	OFF	<ul style="list-style-type: none"> Check connections at relays outputs If the problem persists, return the UG6914 to DOLD to be repaired
Error in communication with master	OFF	5	OFF		OFF	OFF	OFF	<ul style="list-style-type: none"> Restart the system If the problem persists, return the UG6914 to DOLD to be repaired
Error on other slave or UG6911.10	OFF	ON	OFF		OFF	OFF	OFF	<ul style="list-style-type: none"> Restart the system Check which unit is in FAIL mode
Same type of slave with same address detected	OFF	5	5		OFF	OFF	OFF	<ul style="list-style-type: none"> Change the unit's address (see NODE SEL)
external contactors fbk error on Category 4 relay	ON	OFF	4		4 (only the LED corresponding to the output in FAIL mode)		OFF	<ul style="list-style-type: none"> Check connections at pins REST_FBK
Short circuit or overload detected	OFF	3	OFF		3	OSSD output state	OSSD CLEAR state	Flashes
Error on node detection circuit	OFF	3	OFF	3	OFF	OFF	OFF	<ul style="list-style-type: none"> Return the unit to DOLD to be repaired

Table 39 - Troubleshooting UG6914.04/000 and UG6914.04/008

Speed monitoring module UG6917/002, UG6917/x02, UG6917/xx2

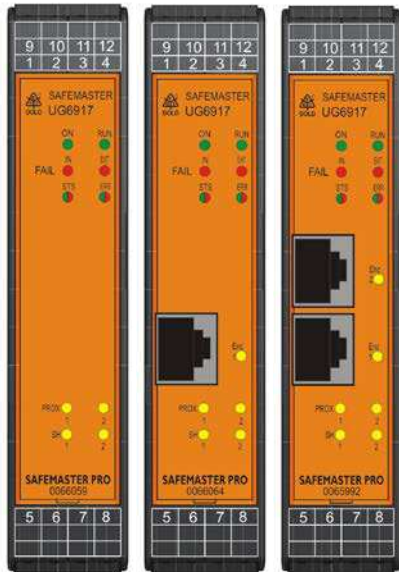

Figure 25
UG6917/002, UG6917/x02,
UG6917/xx2

MEANING	LED (number x = number of flash)							ABHILFE
	RUN	IN FAIL	EXT FAIL	SEL 0/1	ENC *)	PROX	SH	
	GREEN	RED	RED	ORANGE	YELLOW	YELLOW	YELLOW	
Internal fault	OFF	2 or 3	OFF	Shows the physical address of the unit	OFF	OFF	OFF	• Return the unit to DOLD to be repaired
Compatibility error	OFF	5	OFF		OFF	OFF	OFF	• Firmware version not compatible with UIG6911.10, return to DOLD for FW upgrade.
• Encoder not connected but requested from the configuration • Encoder EXTERNAL error	OFF	OFF	3		3	OFF	OFF	• Verify encoder connection and power supply • Verify input frequency (in range)
Encoder INTERNAL error	OFF	3	OFF		3	OFF	OFF	• Change the encoder • Return the unit to DOLD to be repaired
• Proximity not connected but requested from the configuration • Proximity EXTERNAL error	OFF	OFF	3		OFF	3	OFF	• Verify proximity connection and power supply • Verify input frequency (in range)
Proximity INTERNAL error	OFF	3	OFF		OFF	3	OFF	• Change the proximity • Return the unit to DOLD to be repaired
Same type of slave with same address detected	OFF	5	5		OFF	OFF	OFF	• Change the unit's address (see NODE SEL)
Error on node detection circuit	OFF	3	OFF	3	OFF	OFF	OFF	• Return the unit to DOLD to be repaired

Table 40 - Troubleshooting UG6917/002, UG6917/x02 and UG6917/xx2

*) LED ENC not present on UG6917/002

BusExtender module UG6918

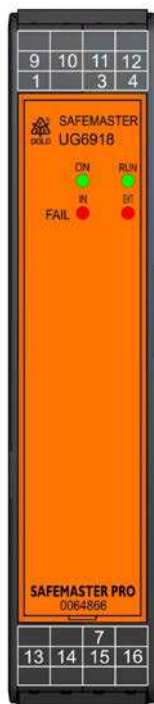

Figure 26
UG6918

MEANING	LED			
	ON (GREEN)	RUN (GREEN)	IN FAIL (RED)	EXT FAIL (RED)
INTERNAL FAULT DETECTED <i>(Not recoverable. Restart the system)</i>	ON	OFF BLINKING	Follows UG6911.10 error codification	OFF
FAULT DETECTED ON TERMINAL CONNECTION <i>(Recoverable)</i>	ON	OFF	OFF	ON

Table 41 - Troubleshooting UG6918

SAFEMASTER PRO DESIGNER SOFTWARE

The "**SAFEMASTER PRO DESIGNER**" software can be used to configure a logic diagram of the connections between the SAFEMASTER PRO (control unit + expansions) and the components of the system being developed.

The SAFEMASTER PRO will thus monitor and control the connected safety components.

The SAFEMASTER PRO DESIGNER uses a versatile graphic interface to establish the connections between the various components, as described below:

Installing the software

PC HARDWARE requirements

- RAM: 256 MB
(adequate to run *Windows XP SP3 + Framework 4 + Framework 4 Extended*)
- Hard disk: \geq 500Mbyte of free space
- USB connector: 1.1, 2.0 or 3.0
- CD-ROM drive

PC SOFTWARE requirements

- Windows XP with Service Pack 3 installed (or higher OS).

➔ Microsoft Framework 4 (with Framework 4 Extended) must be installed on the PC

How to install SAFEMASTER PRO DESIGNER

- Insert the installation CD;
- Wait for the auto-run installer to request the software setup program;
- Alternatively search and open the file SAFEMASTER_PRO_setup.exe;

When the installation procedure is complete a window is displayed asking you to close the setup program.

Fundamentals

Once the SAFEMASTER PRO DESIGNER has been correctly installed it creates an icon on the desktop.



To launch the program: double-click on this icon. =>

The opening screen shown below is displayed:

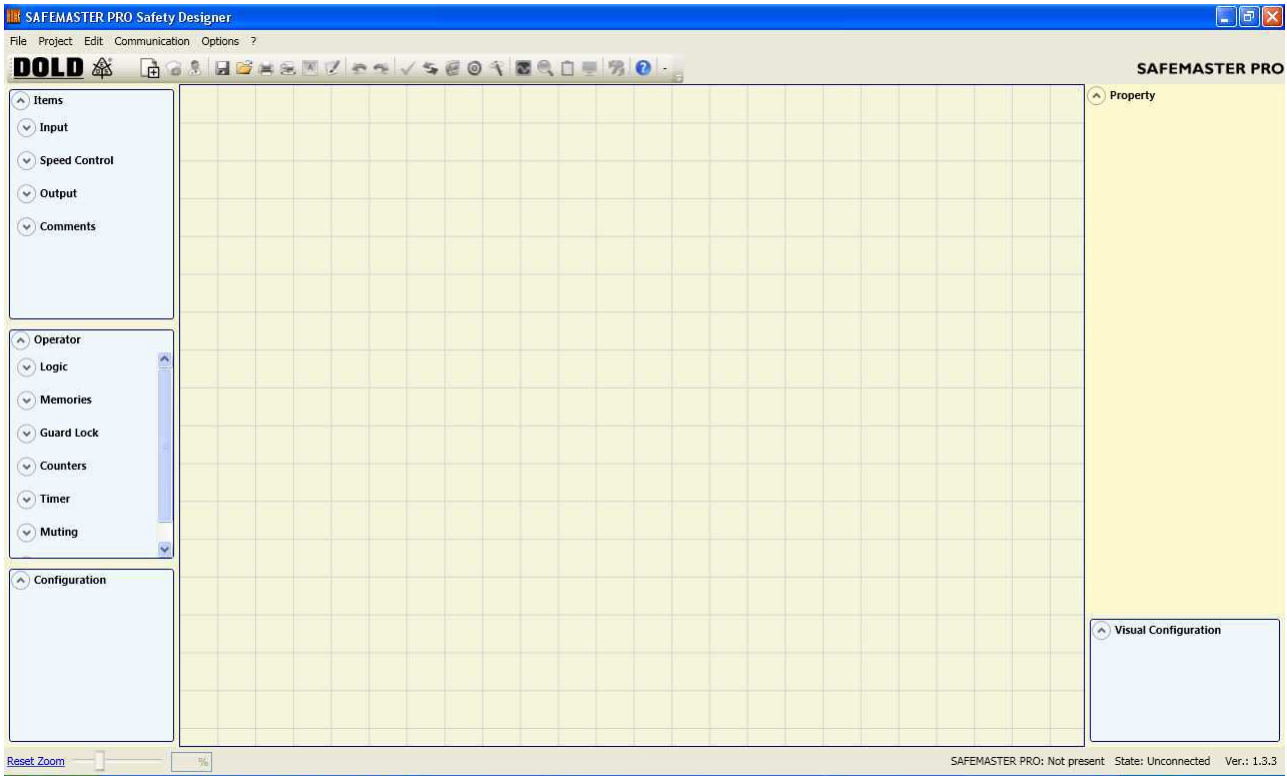

Figure 27

You are now ready to create your project.

Warning

The PFHd, MTTFd and DC values which are shown in “Project report – SAFEMASTER PRO – Safety information” refer exclusively to the internal operation of SAFEMASTER PRO.

For the calculation of the total PFHd values of the various safety functions implemented through SAFEMASTER PRO, however, the effect of the safety components connected with SAFEMASTER PRO has to be taken into account (e.g. sensors and actuators), as described in EN ISO 13849-1, 2 or EN / IEC 62061.

The implemented circuits and electrical diagrams and the system configuration parameter values, including those of SAFEMASTER PRO, are under the full responsibility of the user.

Standard tool bar

The standard tool bar is shown in Figure 28. The meanings of the icons are listed below:























- | | | |
|-------|---|--|
| 1 -> |  | CREATE A NEW PROJECT |
| 2 -> |  | CHANGE CONFIGURATION (arrangement of the different modules) |
| 3 -> |  | CHANGE USER PARAMETERS (name, company, etc.) |
| 4 -> |  | SAVE THE ACTUAL PROJECT |
| 5 -> |  | LOAD AN EXISTING PROJECT |
| 6 -> |  | PRINT THE PROJECT SCHEMATIC |
| 7 -> |  | SHOW PRINT PREVIEW OF PROJECT SCHEMATIC |
| 8 -> |  | SHOW PRINT AREA OF PROJECT SCHEMATIC |
| 9 -> |  | PRINT THE PROJECT REPORT |
| 10 -> |  | UNDO MODIFICATION |
| 11 -> |  | REDO MODIFICATION |
| 12 -> |  | VALIDATE THE PROJECT |
| 13 -> |  | CONNECT TO SAFEMASTER PRO |
| 14 -> |  | SEND PROJECT TO SAFEMASTER PRO |
| 15 -> |  | DISCONNECT FROM SAFEMASTER PRO |
| 16 -> |  | READ PROJECT FROM SAFEMASTER PRO |
| 17 -> |  | MONITOR (Real time I/O graphic) |
| 18 -> |  | MONITOR (Real time I/O Textual) |
| 19 -> |  | UPLOAD LOG FILE |
| 20 -> |  | UPLOAD SYSTEM CONFIGURATION |
| 21 -> |  | CHANGE PASSWORD |
| 22 -> |  | ON-LINE HELP |



Figure 28

Create a new project (configure the SAFEMASTER PRO system)

Select icon CREATE (Figure 28) from the standard tool bar to start a new project. The user authentication window is displayed (Figure 29).

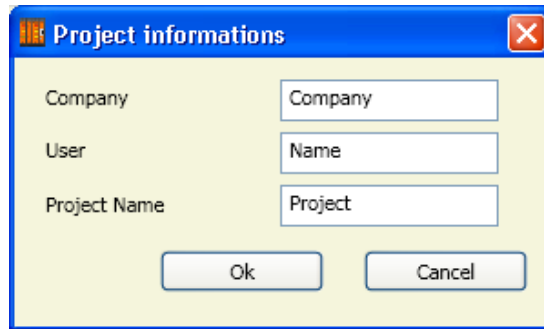
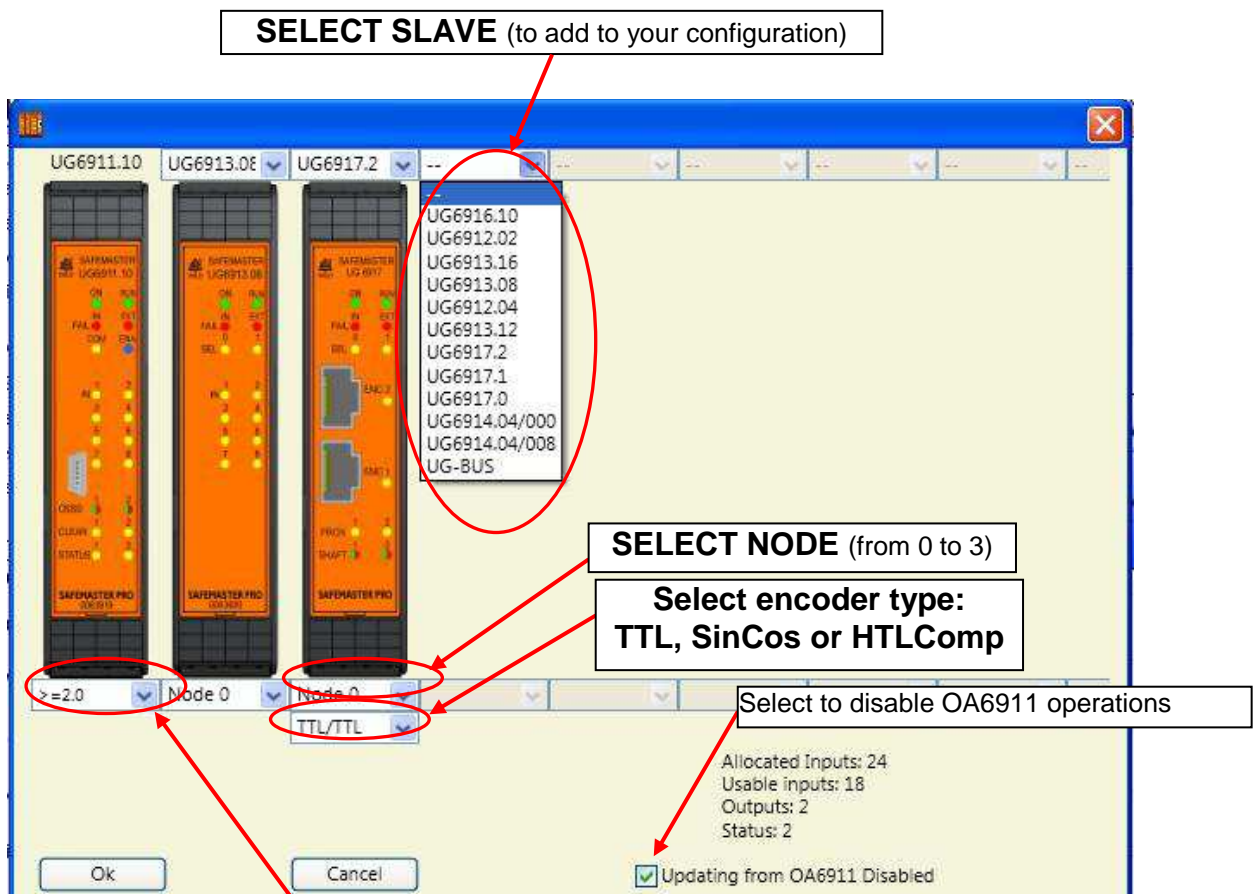

Figure 29

Next the SAFEMASTER PRO DESIGNER displays a window showing the UG6911 only. You may add the various units needed to create your system, using the pull-down menus at the top of the screen (select slave) and at the bottom to select the relative node (0÷4).



Selection of installed firmware in the control unit that should be configured (<=0.3, >=0.4, >=1.0 or >=2.0).

See also section  "System composition"

Figure 30

EDIT CONFIGURATION (composition of the various units)

The change of the system composition is obtained with the icon .

The configuration window is showed again.

Change user parameters

The change of user parameters is obtained with the icon .

The dialog user identification request appears (Figure 31). To accomplish this operation is not necessary to Log out from SAFEMASTER PRO. Generally it serves when a new user must create a new project (even using a previously created).

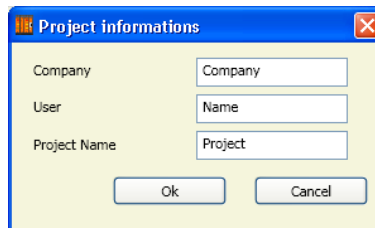

Figure 31

OBJECTS - OPERATOR - CONFIGURATION tool bars

Four large tool windows are displayed to the left and right of the main window (shown in Figure 32):

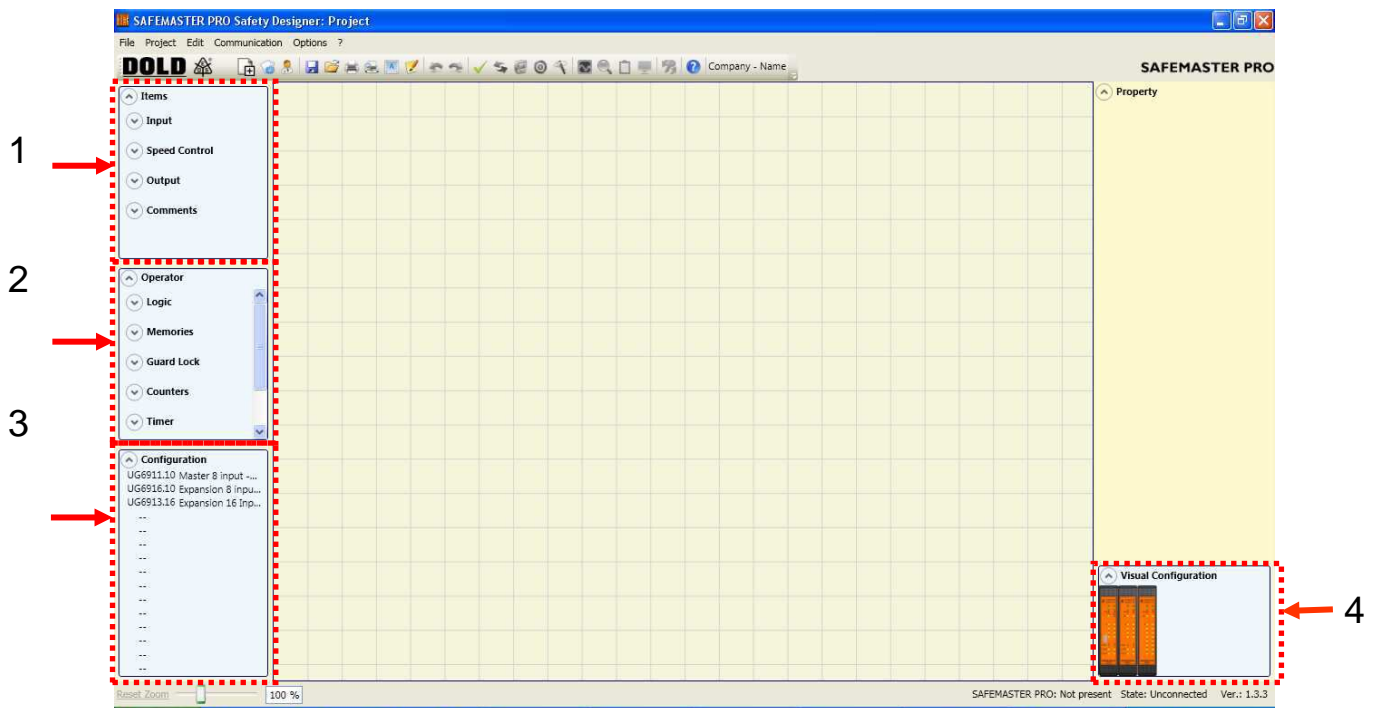

Figure 32

1 > OBJECT TOOL WINDOW

This contains the various input and output function blocks that will make up your project

2 > OPERATOR TOOL WINDOW

This contains the various function blocks for connecting the objects in point 1; these blocks are divided into different types: logical, memories, counters etc.

3 > CONFIGURATION TOOL WINDOW

This contains the description of your project composition.

4 > CONFIGURATION TOOL WINDOW (view)

This contains the graphic representation of your project composition.

Creating the diagram (Figure 16)

Once you have selected your system composition, you are ready to configure the project.

The logic diagram is created using a **DRAG&DROP** function:

- Select the objects as required from the windows described previously (each single object is described in detail in the following sections) and drag it into the design area.
- Now when you select the object the **PROPERTIES** window is enabled, where you must fill in the fields as required.
- When you need to set a specific numerical value with a slide (e.g. filter) use the left and right arrows on your keyboard or click the sides of the slider of the slide.
- Connect the objects by moving the mouse over the required pin and then dragging it onto the pin to be connected.
- If the scheme requires the PAN function (moving working area in the window), select the object or area to move and use the arrow keys on your keyboard.
- When you need to duplicate an object, select it and press CTRL+C / CTRL+V keys on your keyboard.
- When you need to delete an object or a link, select it and press DEL key on your keyboard.
- By click with the right mouse key on object or object area more functions such as copy, insert and show description of object are available.

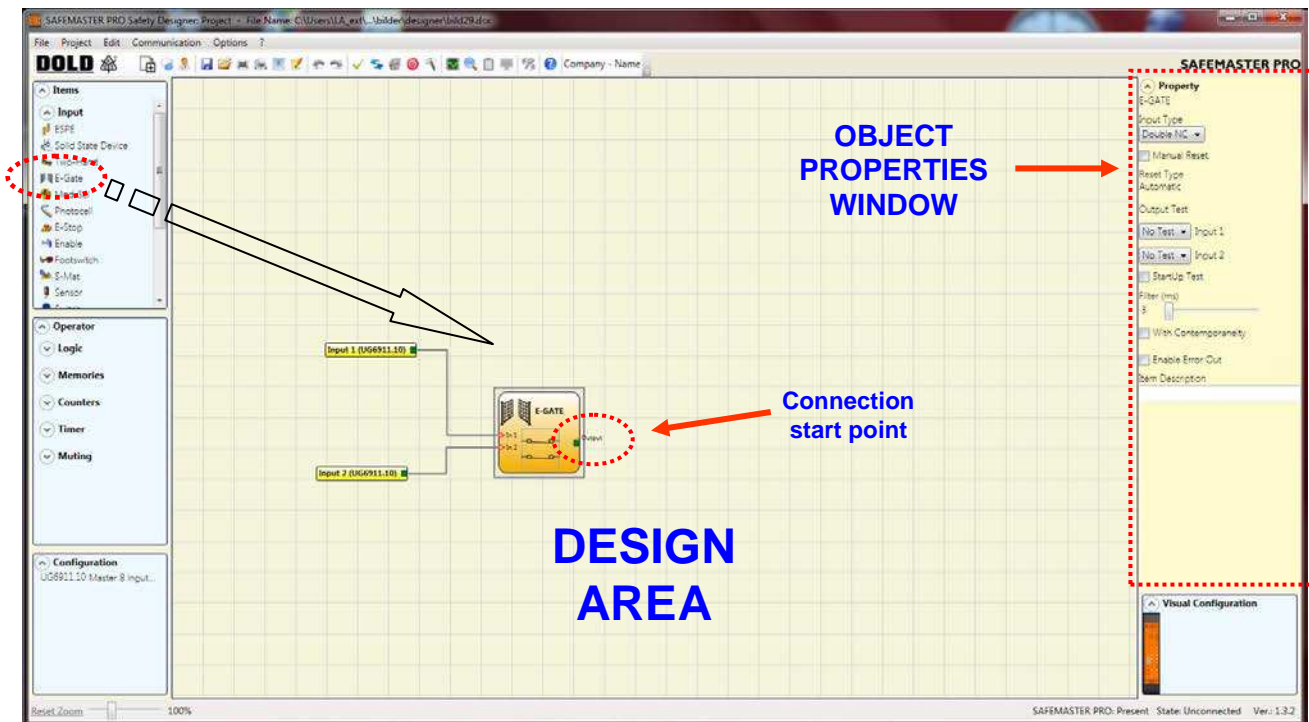

Figure 33

Use of mouse right button

ON BLOCK INPUT / OUTPUT

- Copy / Paste
- Delete
- Delete all the assigned pins
- Alignment with other functional blocks (multiple selection)
- On-line Help
- on block Status: enable / disable input pin logical negation

- Monitor Mode: Show / Hide Properties window

ON BLOCK OPERATORS

- Copy / Paste
- Delete
- Alignment with other functional blocks (multiple selection)
- On-line Help
- On input pin: activate / deactivate logical negation

- Monitor Mode: Show / Hide Properties window

ON Input / Output TERMINALS

- Alignment with other inputs / outputs

ON CONNECTION (WIRES)

- Delete
- Display full path of the connection (network)

Print logic diagram

For print function, 3 symbols are available:



The logic diagram is always one complete picture that can be printed via this symbol. Depending of printer configuration, the logic diagram is cut in several pages.



Print preview can be show with this symbol.



With this symbol, the distribution of the logic diagram to the pages to be printed can be show during generation of the plan. Grey lines show that no objects or function blocs are cut in 2 pages, red lines shows that symbols may be cut at printing.

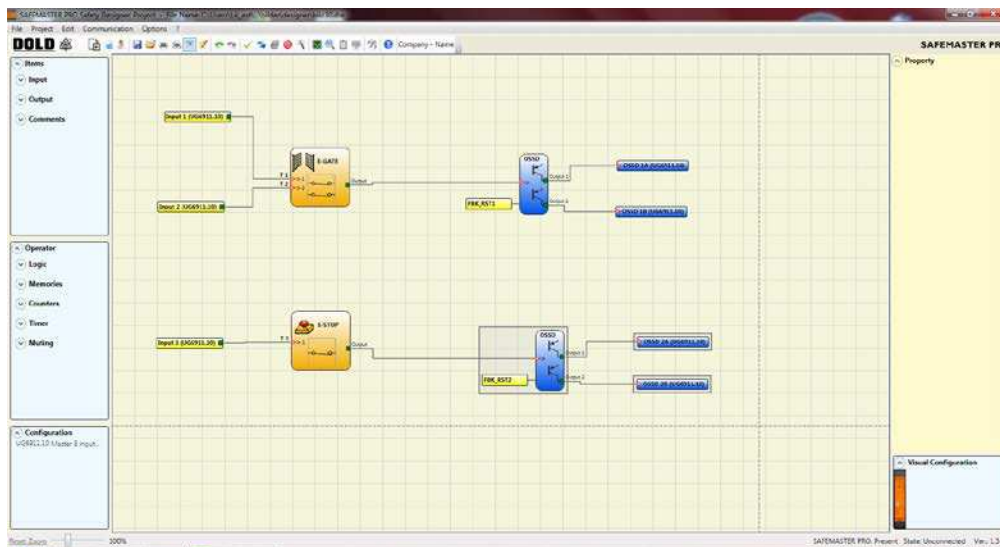

Figure 34
(symbols correctly placed)

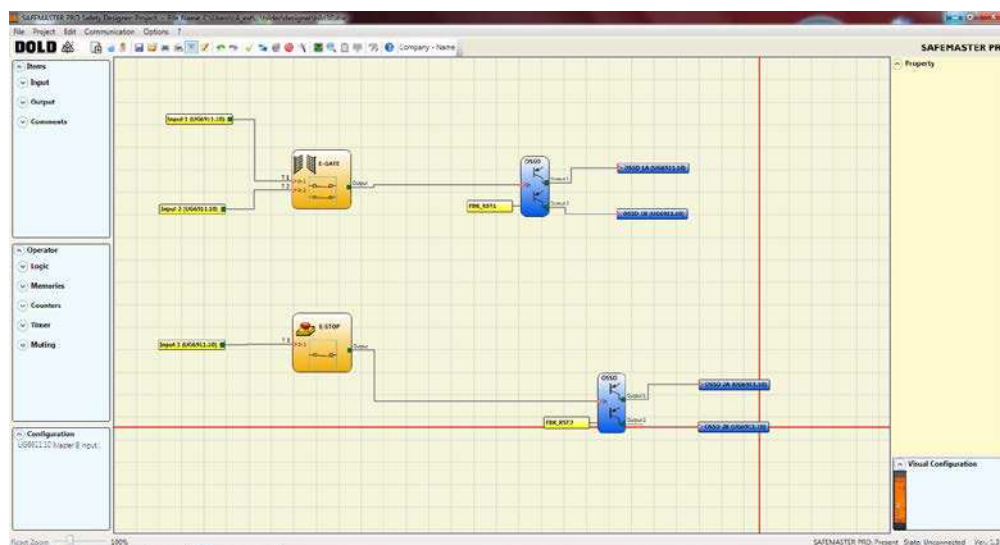

Figure 35
(placement not OK)

Example of a project

Figure 36 shows an example of a project in which the UG6911 unit only is connected to two safety blocks (E-GATE and E-STOP).

The UG6911 inputs (1, 2, and 3) for connecting the contacts of the safety components are shown on the left, in yellow. The SAFEMASTER PRO outputs (from 1 to 4) are activated according to the conditions defined in E-GATE and E-STOP (see the [E-GATE](#) - E-STOP sections).

By clicking on a block to select it, you enable the PROPERTIES WINDOW on the right, which you can use to configure the block activation and test parameters (see the [E-GATE](#) - E-STOP sections).

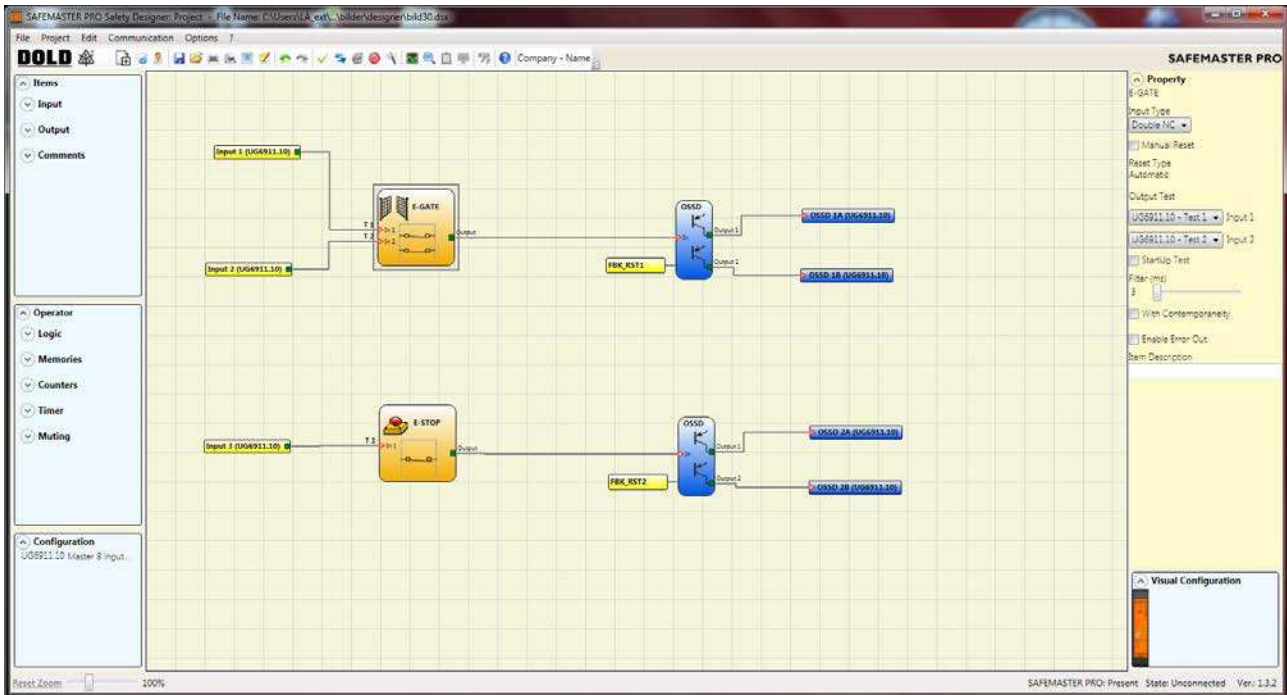

Figure 36

At the end of the project design stage (or at intermediate steps) you can save the current configuration using the icon **SAVES** on the standard tool bar.

Project validation

➔ Now the finished project must be verified. Execute the VALIDATE command (Icon on the standard toolbar).

If the validation is successful, a sequential number is assigned to the input and output of the project. Then, this number is also listed in the REPORT and in the MONITOR of SAFEMASTER PRO DESIGNER.

Only if the validation is successful we will proceed to send the configuration.

The validation function only verifies the consistency of programming with respect to the characteristics of the SAFEMASTER PRO system. It does not guarantee that the device has been programmed to meet all the safety requirements for the application.

Project report

Print of the System composition with properties of each block. (Icon  on the standard toolbar).

Warning

The PFHd, MTTFd and DC values which are shown in “Project report – SAFEMASTER PRO – Safety information” refer exclusively to the internal operation of SAFEMASTER PRO.

For the calculation of the total PFHd values of the various safety functions implemented through SAFEMASTER PRO, however, the effect of the safety components connected with SAFEMASTER PRO has to be taken into account (e.g. sensors and actuators), as described in EN ISO 13849-1, 2 or EN / IEC 62061.

The implemented circuits and electrical diagrams and the system configuration parameter values, including those of SAFEMASTER PRO, are under the full responsibility of the user.

DOLD & SÖHNE KG

Project Report generated by SAFEMASTER PRO Safety Designer version 1.3.2

Project Name: Zweihand_Enable

User: Name

Company: Company

Date: 10.01.2014 11:07:46

Schematic CRC: 0102H

SAFEMASTER PRO: Configuration

Module UG4011.10 (Configured Firmware version: FW >=0.4 <1.0)

SAFEMASTER PRO: Safety Information's

PFHd (according to IEC 61508): 6,06E-009 (1/h)

MTTFd (according to EN ISO 13849-1): 100 years

DCavg (according to EN ISO 13849-1): 97.90 %

Attention!

This definition of PL and of the other related parameters as set forth in ISO 13849-1 only refers to the functions implemented in the SAFEMASTER PRO system by the SAFEMASTER PRO configuration software, assuming configuration has been performed correctly.

The actual PL of the entire application and the relative parameters must consider data for all the devices connected to the SAFEMASTER PRO system within the scope of the application.

This task and any other aspect of system configuration are the exclusive responsibility of the user/installer.

Resources used

INPUT: 88% (7/8)

Functional Blocks: 5

Timing: 38% (3/8)

DFF: 12% (1/8)

Restart: 38% (3/8)

Total number blocks: 59% (19/32)

Created: 10.01.2014



Connect to SAFEMASTER PRO

After connecting the control unit UG6911.10 to the PC via CSU cable (USB) use the icon  for the connection.

A window appears to request the password. Enter the password (see "[Password protection](#)").



Figure 37

Sending the configuration to the SAFEMASTER PRO

To send the saved configuration from a PC to UG6911 use the icon  on the standard toolbar and wait the execution. UG6911 will save the project in its internal memory and (if present) in OA6911 memory. (Password Required: level 2).

➔ This function is possible only after the project validation with OK result.

➔ If the firmware version in the control unit is not identical to the selected firmware version of the configuration file, a failure message is displayed as shown here (example) and the configuration is not transferred.

➔ To transfer the configuration, the configuration file has to be set to the same firmware status as it is installed in the control unit. See also section "[Create a new project \(configure the SAFEMASTER PRO system\)](#)".

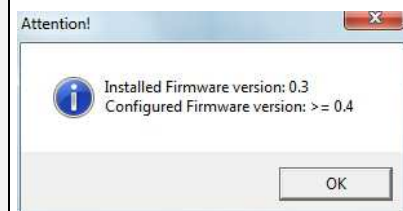

Download a configuration from a SAFEMASTER PRO

Use the icon  on the Standard toolbar to download a project from SAFEMASTER PRO to SAFEMASTER PRO Designer. (Sufficient Password level 1).

Configuration LOG

- ➔ Within the configuration file (project), are included the **creation date** and **CRC (4-digit hexadecimal identification)** of a project that are stored in UG6911.
- ➔ This logbook can record up to 5 consecutive events, after which these are overwritten, starting from the least recent event.

The log file can be visualized using the icon  in the standard tool bar.

(Password Required: level 1).

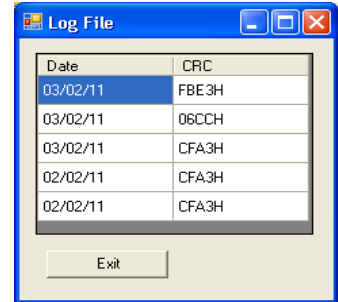



Figure 38

System composition

The check of the actual composition of the SAFEMASTER PRO system is obtained using the icon . (Password Required: level 1). A pop-up window will appear with:

- Connected units;
- Firmware version of each unit;
- Node number (physical address) of each unit.

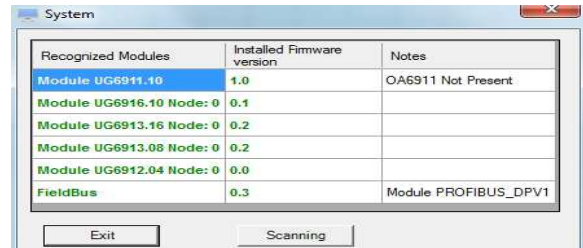

Figure 39

If the modules found are not correct the following window will appear; e.g. UG6916.10 node number not correct (displayed in red color text).

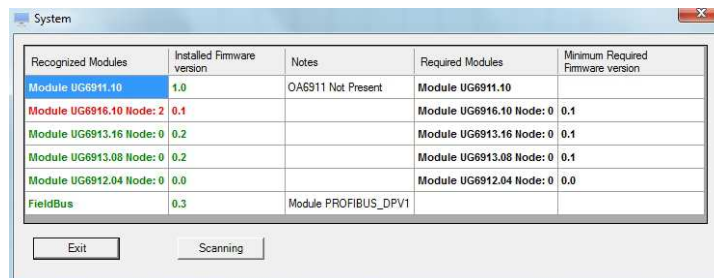



Figure 40

Disconnecting System

To disconnect the PC from UG6911 use the icon ; when the system is disconnected it is reset and it starts with the sent project.

- ➔ If the system is not composed of all units provided by the configuration, after the disconnection, UG6911 indicates the incongruity and does not starts. (See [Visualizations](#) and [Error codes from SAFEMASTER PRO Designer](#)).

Error codes from SAFEMASTER PRO Designer

In case of malfunction the SAFEMASTER PRO system transmits to the SAFEMASTER PRO Designer a code corresponding to the error detected by the UG6911.10 unit.

To read the code, proceed as follows:

- connect the UG6911.10 (indicating Fail) to the PC using the USB-cable
- launch the SAFEMASTER PRO Designer, a window appears with the error code occurred.

The following table lists all possible errors detected and their solution:

CODE	FAIL	RESOLUTION
19D	<i>The two UG6911 microcontrollers do not see the same hw / sw configuration</i>	CHECK CORRECT INSERTION OF UG6911 AND EXPANSION MODULES ON IN-RAIL BUS.
66D	<i>2 or more same expansion modules with the same node number</i>	CHECK THE CONNECTIONS PIN 2, 3 EXPANSION MODULES
68D	<i>Exceeded max expansion modules number</i>	DISCONNECT THE MODULES IN EXCESS (MAX14)
70D	<i>One or more modules have detected a change in the node number</i>	CHECK THE CONNECTIONS OF PIN 2, 3 EXPANSION MODULES
73D	<i>A slave module has detected an external error</i>	CHECK THE ERROR CODE ON MODULE FOR MORE INFORMATION
96D ÷ 101D	<i>Errors related to memory card OA6911</i>	REPLACE MEMORY CARD OA6911
<i>UG6914</i>		
137D	<i>EDM error on the couple RELAY1 and 2 used in Category 4</i>	CHECK THE CONNECTION OF THE EXTERNAL FEEDBACK CONTACTORS
147D	<i>EDM error on the Relay 2 and 3 used in Category 4</i>	
157D	<i>EDM error on the Relay 3 and 4 used in Category 4</i>	
<i>UG6917</i>		
133D (Proxi1) 140D (Proxi2)	<i>over-frequency detected on Proximity input</i>	THE INPUT FREQUENCY MUST BE < 5KHz
136D (encoder1) 143D (encoder2)	<i>Input signals not standard (duty cycle, phase displacement)</i>	<ul style="list-style-type: none"> •THE DUTY CYCLE MUST BE: 50%±33% OF THE PERIOD (HTL, TTL). •THE PHASE DISPLACEMENT MUST BE: 90°±33% (HTL, TTL) (not applicable to SIN / COS)
138D (encoder1) 145D (encoder2)	<i>over-frequency detected on Encoder input</i>	THE INPUT FREQUENCY MUST BE: < 500KHz (TTL, SIN/COS); < 300KHz (HTL).
194D 197D 198D 199D 201D 202D 203D 205D	<i>Errors solid state output OSSD1</i>	CHECK THE OSSD1 CONNECTIONS RELATIVE TO THE MODULE IN ERROR
208D 211D 212D 213D 215D 216D 217D 219D	<i>Errors solid state output OSSD2</i>	CHECK THE OSSD2 CONNECTIONS RELATIVE TO THE MODULE IN ERROR
222D 225D 226D 227D 229D 230D 231D 233D	<i>Errors solid state output OSSD3</i>	CHECK THE OSSD3 CONNECTIONS RELATIVE TO THE MODULE IN ERROR
236D 239D 240D 241D 243D 244D 245D 247D	<i>Errors solid state output OSSD4</i>	CHECK THE OSSD4 CONNECTIONS RELATIVE TO THE MODULE IN ERROR

All other codes are related to errors or an internal malfunction. Please replace the module that gave the error or return to DOLD for repair and / or debugging.

CODE	FAIL	RESOLUTION
1D ÷ 31D	Microcontroller error	Try to restart the system. If the error persists, send unit to Dold Laboratory for repair.
32D ÷ 63D	Mainboard error	
64D ÷ 95D	Communication error between units	
96D ÷ 127D	Errors related to memory card OA6911	REPLACE MEMORY CARD OA6911
128D ÷ 138D	Error module UG6914 relay 1	Try to restart the system. If the error persists, send unit to Dold Laboratory for repair.
139D ÷ 148D	Error module UG6914 relay 2	
149D ÷ 158D	Error module UG6914 relay 3	
159D ÷ 168D	Error module UG6914 relay 4	
128D ÷ 191D	Error modules UG6917- encoder interface	Try to restart the system. If the error persists, send unit to Dold Laboratory for repair.
192D ÷ 205D	OSSD1 error	
206D ÷ 219D	OSSD2 error	
220D ÷ 233D	OSSD3 error	
234D ÷ 247D	OSSD4 error	

MONITOR (I/O status in Textual)

To activate the monitor use the icon . (Password Required: level 1).
 A pop-up window will appear **(in real time)** with:

- Status of the inputs (when the object has two or more input connections to SAFEMASTER PRO, the MONITOR will show as active only the first), see the example in figure;
- Inputs Diagnostics;
- OSSD State;
- OSSD Diagnostics;
- Status of digital outputs;
- OUT TEST diagnostics.

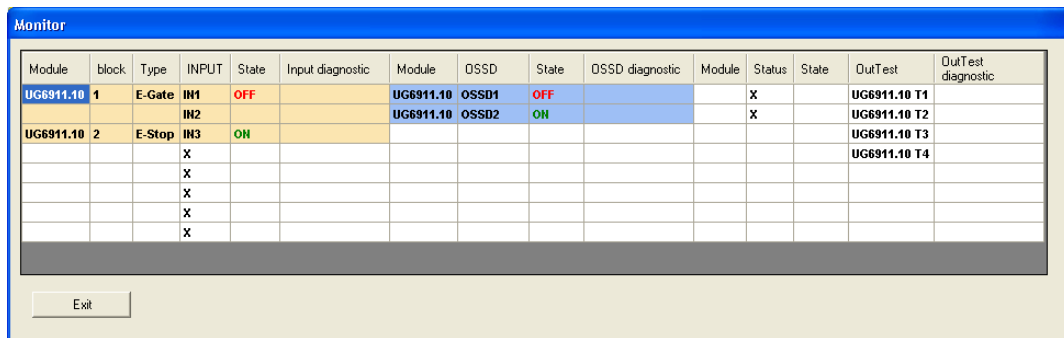

Module	block	Type	INPUT	State	Input diagnostic	Module	OSSD	State	OSSD diagnostic	Module	Status	State	OutTest	OutTest diagnostic
UG6911.10	1	E-Gate	IN1	OFF		UG6911.10	OSSD1	OFF			X		UG6911.10 T1	
			IN2			UG6911.10	OSSD2	ON			X		UG6911.10 T2	
UG6911.10	2	E-Stop	IN3	ON									UG6911.10 T3	
			X										UG6911.10 T4	
			X											
			X											
			X											
			X											

Figure 41 Textual monitor

MONITOR (I/O status in real time - textual - graphic)

To activate/deactivate the monitor use the icon . (Password Required: level 1).
The color of links (Figure 33) allows you to view the diagnostics (**in real time**) with:

RED = OFF

GREEN = ON

DASHED ORANGE = Connection Error

DASHED RED = Pending enable (for example RESTART)

Placing the mouse pointer over the link, you can display the diagnostics.

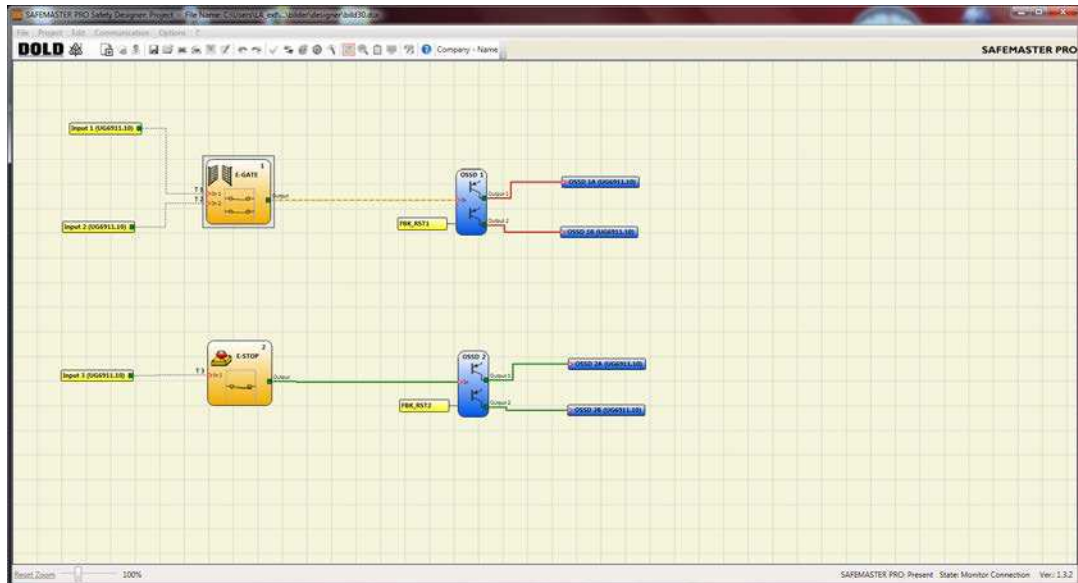

Figure 42

Password protection

The SAFEMASTER PRO DESIGNER requests a password in order to upload and save the project.

Level 1 password

All operators using the UG6911 system must have a Level 1 PASSWORD.

This Password allows only to view the LOG file, composition of the system and MONITOR in real time.

The first time the system is initialized the operator must use the password "" (ENTER key).

Designers who know the level 2 password can enter a new level 1 password (alphanumerical, max 8 characters).

➔ Operators who know this password **are not enabled** to upload, modify or save the project.

Level 2 password

Designers authorized to work on the creation of the project must know a Level 2 PASSWORD. The first time the system is initialized the operator must use the password "**SAFEPASS**" (all capital letters).

Designers who know the level 2 password can enter a new level 2 password (alphanumerical, max 8 characters).

➔ This password **enables** the project to be uploaded, modified and saved. In other words, it allows total control of the PC =>SAFEMASTER PRO system.

When a new project is UPLOADED the level 2 password could be changed.

➔ Should you forget either of these passwords, please contact DOLD which will provide an unlock file. When this file is saved in the directory in which the SAFEMASTER PRO

DESIGNER software is installed, the following icon  appears in the standard tool bar. Now it is possible to restore the original password "" and "SAFEPASS" in the control unit, (the control unit must be switched on and connected to the PC).

This procedure can only be done once for every control unit. For a second reset the control unit has to be sent back to the manufacturer.

Password Change

To activate the PASSWORD Change use icon , after connecting with Level 2 Password.

A window appears (Figure 43) allowing the choice of the new password; insert the old and new passwords in the appropriate fields (max 8 characters). Click OK.

At the end of the operation disconnect to restart the system.

If OA6911 is present the new password is also saved in it.



Figure 43

TESTING the system

 After validating and uploading the project to the UG6911 and connecting all the safety devices, you must test the system to verify its correct operation.

This is done by forcing a change of status for each safety device connected to the SAFEMASTER PRO to check that the status of the outputs actually changes.

The following example is helpful for understanding the TEST procedure.

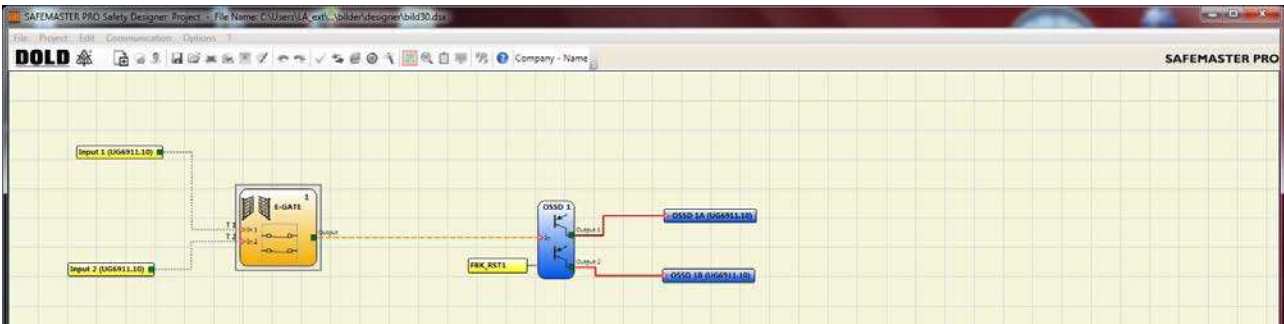
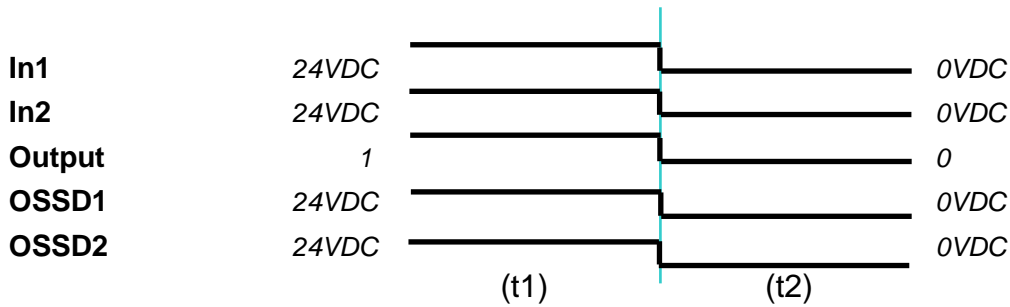



Figure 44

- (t1) In the normal operating condition (E-GATE closed) Input1 and Input2 are closed and the output of the E-GATE block is set to high logic level; in this mode the safety outputs (OSSD1/2) are active and the power supply to the relative terminals is 24VDC.
- (t2) When the E-GATE is **physically** opened, the condition of the inputs and thus of the outputs of the E-GATE block will change: (Output = 1--->0); **the condition of the OSSD1-OSSD2 safety outputs will change from 24VDC to 0VDC**. If this change is detected the mobile E-GATE is connected correctly.



 For the correct installation of each external sensor/component refer to their installation manual.

 This test must be performed for each safety component in the project.

OBJECT FUNCTION BLOCKS

OUTPUT OBJECTS

OSSD (safety outputs)

The OSSD semiconductor safety outputs require no maintenance, Output1 and Output2 supply 24VDC if the input is 1 (TRUE), whereas they supply 0VDC if the input is 0 (FALSE).

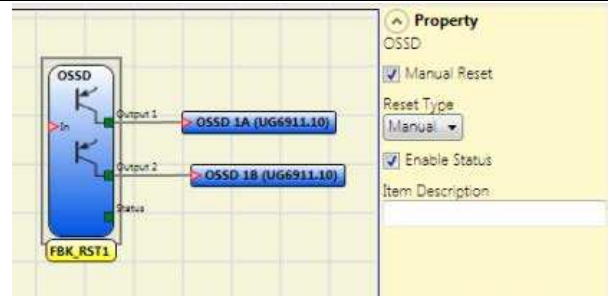

➔ Each pair of OSSD has an entrance on RESTART_FBK. This input must always be connected as described in paragraph [RESTART_FBK](#).

Parameters

Manual Reset: If selected this enables the request to reset each time the input signal falls. Otherwise, enabling of the output directly follows the input conditions.

There are two types of reset: Manual and Monitored. When Manual is selected the system only verifies the signal's transition from 0 to 1. If Monitored is selected the double transition from 0 to 1 and then back to 0 is verified.

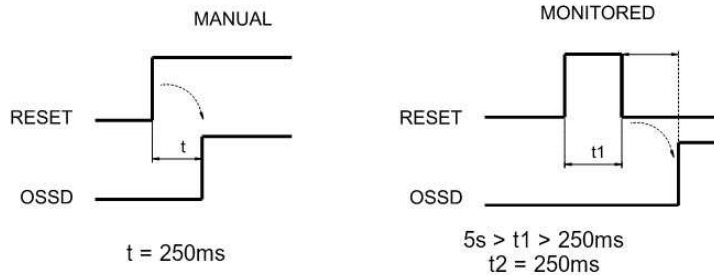

Enable Status: If selected, a status output is available for connection to the logic diagram.

K external time check: If selected, enables the setting of the time window within which the external feedback signal is to be monitored (according to output conditions).
With high level (TRUE) OUTPUT, the FBK signal must be at low level (FALSE) and vice versa, within the set time.

Enable Error Out: If selected, enables the ERROR OUT output. This output is set to high level (TRUE) when an external FBK error is detected. The signal is reset in case of one of the following events:

1. Switching on and switching off of system.
2. Activation of the RESET UG6911 operator.

Item Description: This allows a description of the component's function to be entered. The text is displayed in the top part of the symbol.

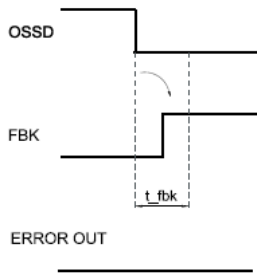

Example of OSSD with correct Feedback signal:
In this case ERROR OUT = FALSE

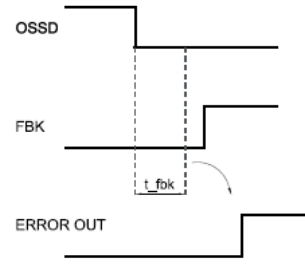

Example of OSSD with incorrect Feedback signal (k external time exceeded):
In this case ERROR OUT = TRUE

RELAY (safety output)

Relay Outputs are N.O. relay contact. They are closed if the input in is 1(TRUE), otherwise the contact is open (FALSE).

Parameters

Category: With this selection is it possible to select between 3 different Categories relay output:

Category 1 single relay output: Each UG6914 module could have up to 4 of this relay output.

Category 2 single relay output: With OTE feature.
Each UG6914 module could have up to 4 of this relay output.
OTE: The OTE (Output Test Equipment) is normally at 1 (TRUE) except in case of internal failure or external contactors feedback failures 0 (FALSE).

Category 4 relay output: Each UG6914 module could have up to 2 of this relay output. With this selection the relay output are used pairs.

Manual Reset and Reset type: If selected enables the request to restart each time after the input signal falls. Otherwise, enabling of the output directly follows the input conditions.

There are two types of reset: Manual and Monitored. When Manual is selected the system only verifies the signal's transition from 0 to 1. If Monitored is selected the double transition from 0 to 1 and then back to 0 is verified.

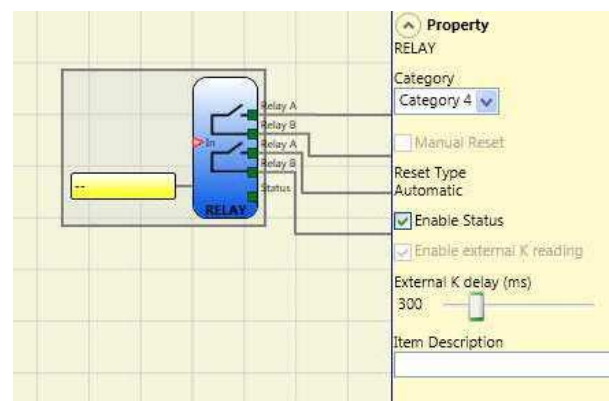
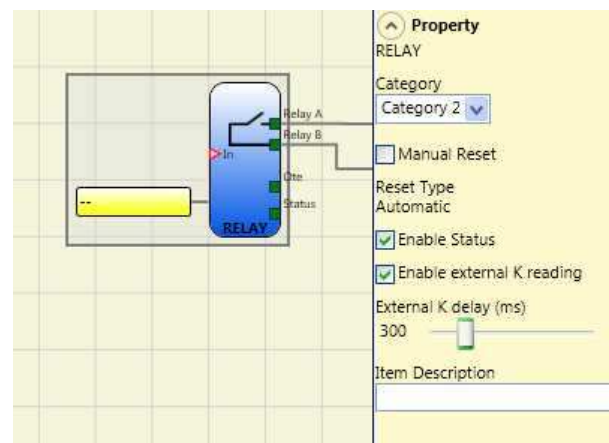
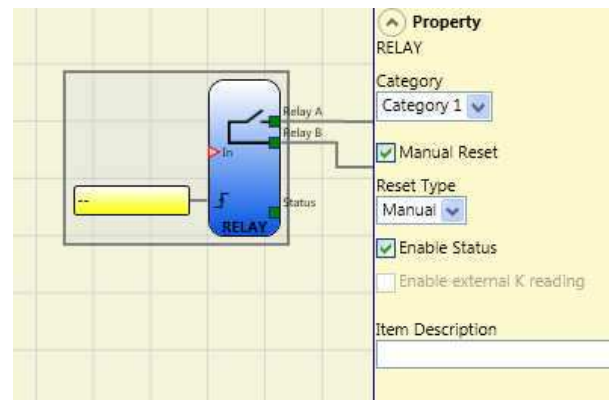

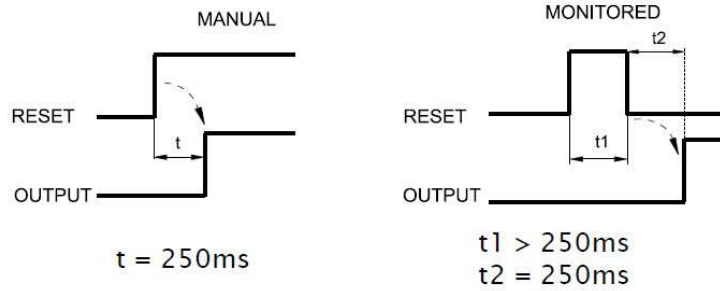

Enable Status: If checked enables the connection of the current status of the Relay output with a STATUS output.

Enable external K reading: If checked enables the reading of the external contactors feedback:

- With Category 1 relay output this features is not available.
- With Category 4 relay output this features is mandatory (always checked).

External K delay (ms): Select the maximum admissible delay introduced by the external contactors. This timing verifies the time between the activation (or deactivation) of the relay and the reading of its feedback for both the transitions (from ON to off and from OFF to ON).

Item Description: This allows a description of the component's function to be entered. The text is displayed in the top part of the symbol.

STATUS (signal output)

The STATUS output makes it possible to monitor any point on the diagram by connecting it to the input. The output returns 24VDC if the input is 1 (TRUE), or 0VDC if the input is 0 (FALSE).

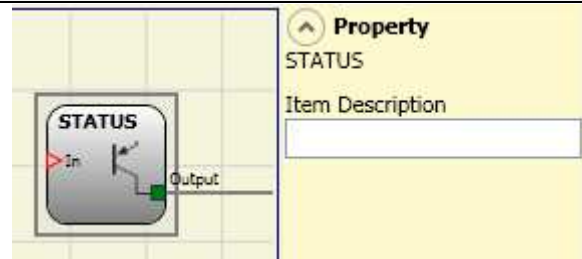

 **WARNING:** The STATUS output is NOT a safety output.

FIELDBUS PROBE

Element that permits display of the status of any point of the scheme on the fieldbus. Up to 16 probes can be inserted and the bit on which status is represented must be entered for each. States are represented with 2 bytes on the fieldbus.

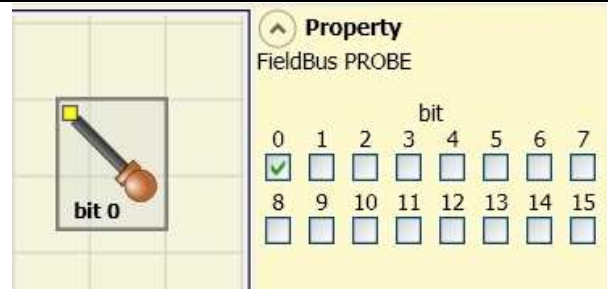

(For more detailed information, consult the fieldbus manual on the SAFEMASTER PRO Designer CD-ROM).

 **WARNING:** the PROBE output is NOT a safety output

INPUT OBJECTS

E-STOP (emergency stop)

The E-STOP function block verifies the status of the inputs of an emergency stop device. If the emergency stop button has been pressed the output is 0 (FALSE). If not the output is 1 (TRUE)

Parameters

Input Type:

- Single NC – allows connection of single channel emergency stop buttons
- Double NC – allows connection of dual channel emergency stop buttons.

Manual Reset: If selected this enables the request to reset each time the emergency stop is activated. Otherwise, enabling of the output directly follows the input conditions.

There are two types of reset: Manual and Monitored. When Manual is selected the system only verifies the signal's transition from 0 to 1. If Monitored is selected the double transition from 0 to 1 and then back to 0 is verified.

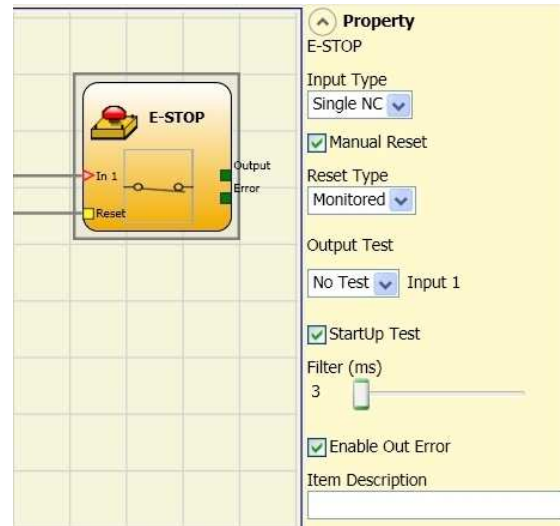

➔ **WARNING:** If the Manual Reset is active, a consecutive Input has to be used. Ex.: Input 1 and Input 2 are used for the functional block, then Input 3 has to be used for the Reset Input.

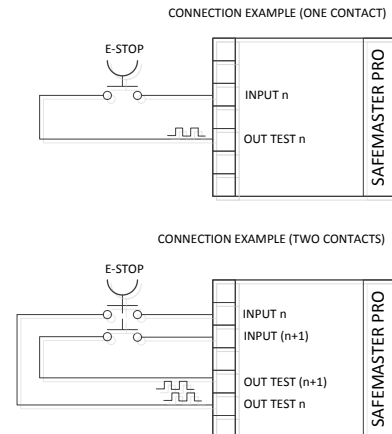
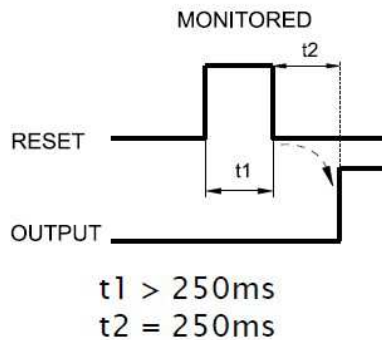
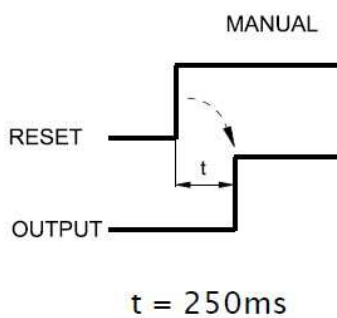

Output Test: This is used to select which test output signals are to be sent to the emergency stop (mushroom pushbutton). This additional test makes it possible to detect and manage any short-circuits between the lines. There is a choice of up to 8 possible test output signals, Test Output 1 ÷ Test Output 8 (depending on used module).

Startup Test: If selected this enables the test at start-up of the external component (emergency stop). This test is performed by pressing and releasing the pushbutton to run a complete function test and enable the output. This test is only requested at machine start-up (when the unit is switched on).

Filter (ms): This is used to filter the signals coming from the emergency stop. The filter can be configured to between 3 and 250ms and eliminates any bouncing on the contacts. The length of the filter affects the calculation of the unit's total response time.

With Simultaneity: If selected this activates the test to verify simultaneous switching of the signals coming from the emergency stop.

Simultaneity (ms): This is only active if the previous parameter is enabled. It defines the maximum time (in msec) between the switching of two different signals from the emergency stop.

Enable Error Out: If selected reports a fault detected by the function block.

Item Description: This allows a description of the component's function to be entered. The text is displayed in the top part of the symbol.

E-GATE (safety gate device)

The E-GATE function block verifies the input status of a mobile guard or safety gate device. If the mobile guard or safety gate is open, the output is 0 (FALSE). Otherwise the output is 1 (TRUE).

Parameters

Input Type:

- Double NC – Allows connection of components with two NC contacts
- Double NC/NO – Allows connection of components with one NO contact and one NC.

Manual Reset: If selected this enables the request to reset each time the mobile guard/safety gate is activated. Otherwise, enabling of the output directly follows the input conditions.

There are two types of reset: Manual and Monitored. When Manual is selected the system only verifies the signal's transition from 0 to 1. If Monitored is selected the double transition from 0 to 1 and then back to 0 is verified.

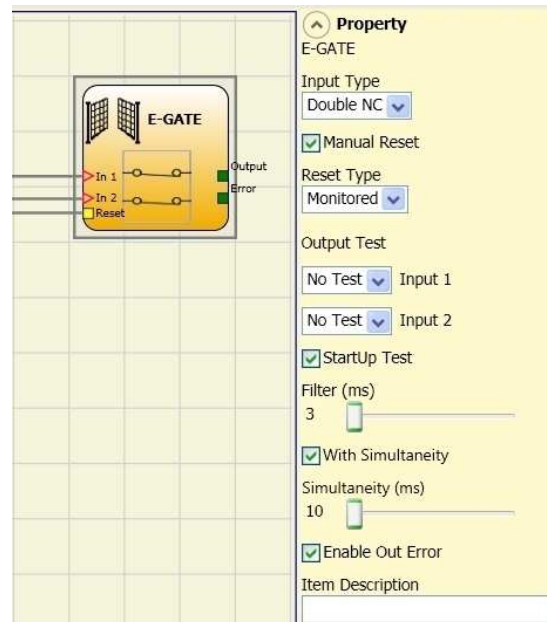

➔ **WARNING:** If the Manual Reset is active, a consecutive Input has to be used. Ex.: Input 1 and Input 2 are used for the functional block, then Input 3 has to be used for the Reset Input.

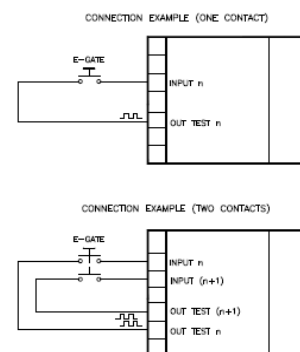
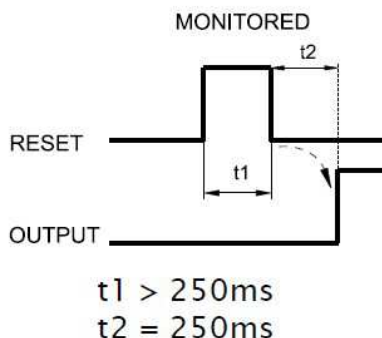
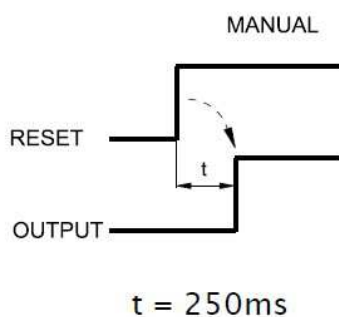

Output Test: This is used to select which test output signals are to be sent to the component contacts. This additional test makes it possible to detect and manage any short-circuits between the lines. There is a choice of up to 8 possible test output signals, Test Output 1 ÷ Test Output 8 (depending on used module).

StartUp Test: If selected this enables the test at start-up of the external component. This test is performed by opening the mobile guard or safety gate to run a complete function test and enable the output. This test is only requested at machine start-up (when the unit is switched on).

Filter (ms): This is used to filter the signals coming from the external contacts. The filter can be configured to between 3 and 250ms and eliminates any bouncing on the contacts. The length of the filter affects the calculation of the unit's total response time.

With Simultaneity: If selected this activates the test to verify simultaneous switching of the signals coming from the external contacts.

Simultaneity (ms): This is only active if the previous parameter is enabled. It defines the maximum time (in msec) between the switching of two different signals from the external contacts.

Enable Error Out: If selected reports a fault detected by the function block.

Item Description: This allows a description of the component's function to be entered. The text is displayed in the top part of the symbol.

SINGLE E-GATE (Safety gate device)

SINGLE E-GATE function block verifies a mobile guard or safety gate device input status. If the mobile guard or safety gate is open, the output is 0 (FALSE). Otherwise the output is 1 (TRUE).

Parameters

Enable reset: If selected this enables the request to reset each time the mobile guard/safety gate is activated. Otherwise, enabling of the output directly follows the input conditions. There are two types of reset: *Manual and Monitored*. When Manual is selected the system only verifies the signal's transition from 0 to 1. If Monitored is selected the double transition from 0 to 1 and then back to 0 is verified.

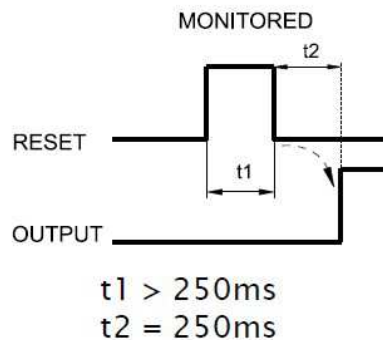
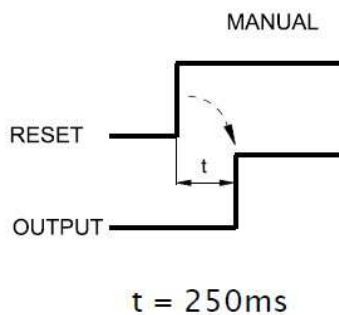
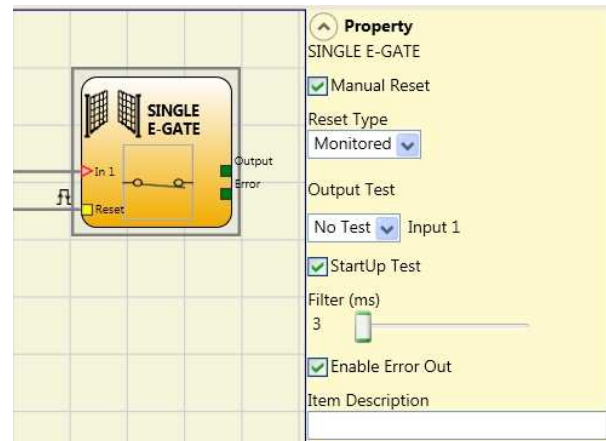

➔ WARNING: If the Manual Reset is active, a consecutive Input has to be used. Ex.: Input 1 is used for the functional block, then Input 2 has to be used for the Reset Input.

Output test: This is used to select which test output signals are to be sent to the component contacts. This additional control permits detection and management of any short-circuits between the lines. To enable this control, the test output signals must be configured (amongst those available).

Test at start-up: If selected this enables the test at start-up of the external component. This test is performed by opening the mobile guard or safety gate to run a complete function test and enable the output. This test is only requested at machine start-up (when the unit is switched on).

Filter (ms): This is used to filter the signals coming from the external contacts. The filter can be configured to between 3 and 250ms and eliminates any bouncing on the contacts. The length of the filter affects the calculation of the unit's total response time.

Enable Error Out: If selected reports a fault detected by the function block.

Item description: This allows a description of the component's function to be entered. The text is displayed in the top part of the symbol.

LOCK FEEDBACK

The function block LOCK FEEDBACK verifies the lock status of a guard lock device for mobile guard or safety gate. In the case where the inputs indicate that the guard is locked the Output will be 1 (TRUE). Otherwise the output is 0 (FALSE).

Parameters

Input type:

- Single NO – Allows connection of components with one NO contact;
- Double NO – Allows connection of components with two NO contacts.
- Double NC/NO – Allows connection of components with one NO contact and one NC.

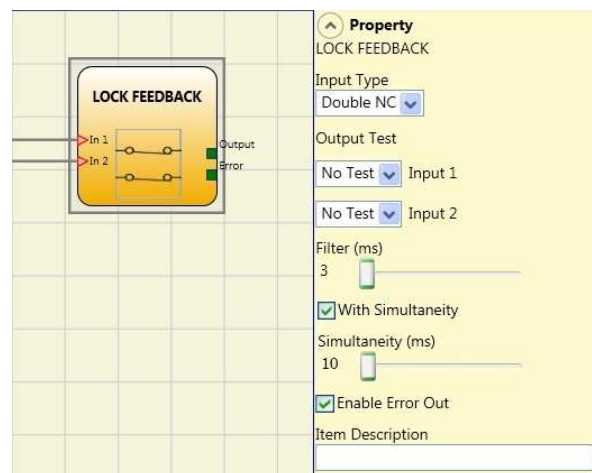

Output test: This is used to select which test output signals are to be sent to the component contacts. This additional control permits detection and management of any short-circuits between the lines. To enable this control, the test output signals must be configured (amongst those available).

Filter (ms): This is used to filter the signals coming from the external contacts. The filter can be configured to between 3 and 250ms and eliminates any bouncing on the contacts. The length of the filter affects the calculation of the unit's total response time.

With Simultaneity: If selected this activates the test to verify concurrent switching of the signals coming from the external contacts.

Simultaneity (ms): This is only active if the previous parameter is enabled. It defines the maximum time (in msecs) between the switching of two different signals from the external contacts.

Enable Error Out: If selected reports a fault detected by the function block.

Item description: This allows a description of the component's function to be entered. The text is displayed in the top part of the symbol.

ENABLE (enable key)

The ENABLE function block verifies the status of the inputs of a manual key device. If the key is not turned the output is 0 (FALSE). Otherwise the output is 1 (TRUE).

Parameters

Input Type

- Single NO – Allows connection of components with two NO contacts
- Double NO – Allows connection of components with two NO contacts.

Manual Reset: If selected this enables the request to reset each time the command is activated. Otherwise, enabling of the output directly follows the input conditions.

There are two types of reset: Manual and Monitored. When Manual is selected the system only verifies the signal's transition from 0 to 1. If Monitored is selected the double transition from 0 to 1 and then back to 0 is verified.

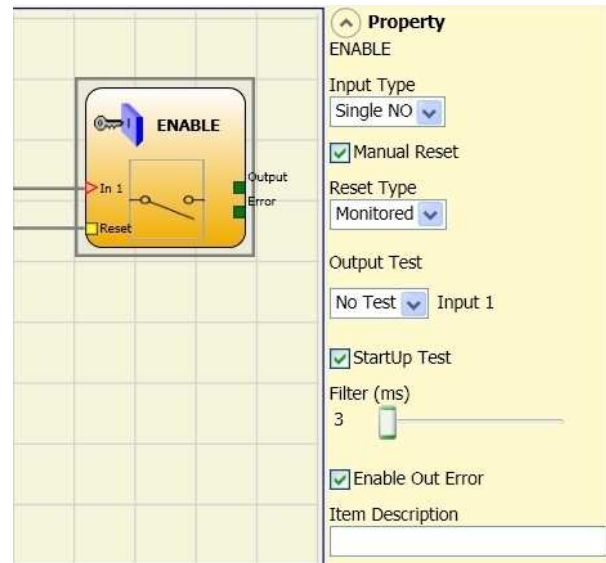

➔ **WARNING:** If the Manual Reset is active, a consecutive Input has to be used. Ex.: Input 1 and Input 2 are used for the functional block, then Input 3 has to be used for the Reset Input.

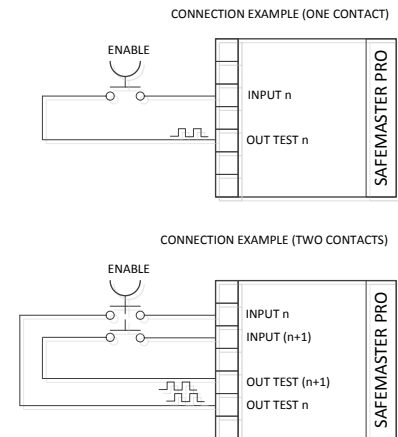
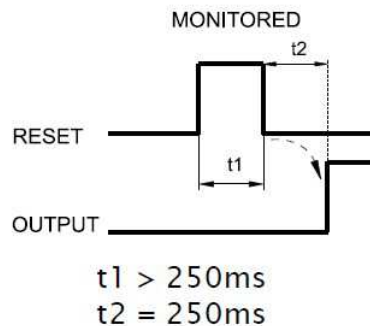
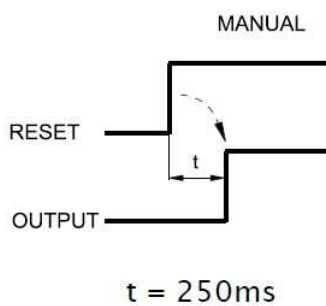

Output test: This is used to select which test output signals are to be sent to the component contacts. This additional test makes it possible to detect and manage any short-circuits between the lines. There is a choice of up to 8 possible test output signals, Test Output 1 ÷ Test Output 8 (depending on used module).

StartUp Test: If selected this enables the test at start-up of the external component. This test is performed by opening and closing the contacts of the ENABLE-Switch to run a complete function test and enable the output. This test is only requested at machine start-up (when the unit is switched on).

Filter (ms): This is used to filter the signals coming from the external contacts. The filter can be configured to between 3 and 250ms and eliminates any bouncing on the contacts. The length of the filter affects the calculation of the unit's total response time.

With Simultaneity: If selected this activates the test to verify simultaneous switching of the signals coming from the external contacts.

Simultaneity (ms): This is only active if the previous parameter is enabled. It defines the maximum time (in msec) between the switching of two different signals from the external contacts.

Enable Error Out: If selected reports a fault detected by the function block.

Item Description: This allows a description of the component's function to be entered. The text is displayed in the top part of the symbol.

ESPE (optoelectronic safety light curtain / laser scanner)

The ESPE function block verifies the state of the inputs of an optoelectronic safety light curtain (or laser scanner). If the area protected by the light curtain is occupied, (light curtain outputs FALSE) the output is 0 (FALSE). Otherwise, with the area clear and outputs to 1 (TRUE) the output is 1 (TRUE).

Parameters

Manual Reset: If selected this enables the request to reset each time the area protected by the safety light curtain is occupied. Otherwise, enabling of the output directly follows the input conditions.

There are two types of reset: Manual and Monitored. When Manual is selected the system only verifies the signal's transition from 0 to 1. If Monitored is selected the double transition from 0 to 1 and then back to 0 is verified.

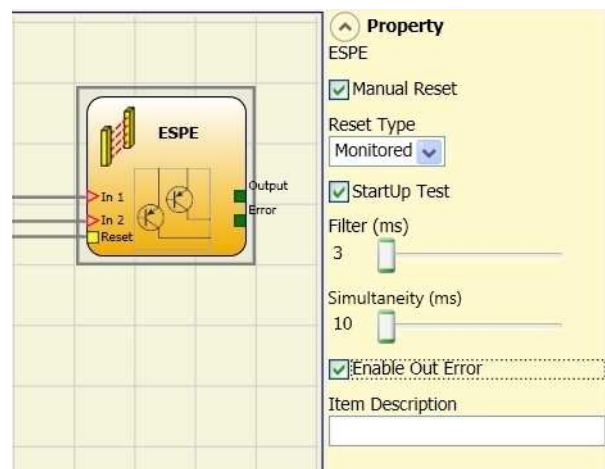

➔ **WARNING:** If the Manual Reset is active, a consecutive Input has to be used. Ex.: Input 1 and Input 2 are used for the functional block, then Input 3 has to be used for the Reset Input.

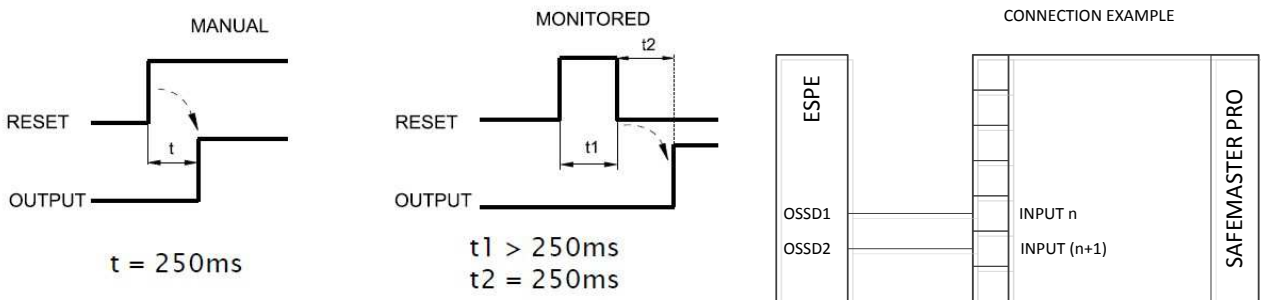

StartUp Test: If selected this enables the test at start-up of the safety light curtain. This test is performed by occupying and clearing the area protected by the safety light curtain to run a complete function test and enable the output. This test is only requested at machine start-up (when the unit is switched on).

Filter (ms): This is used to filter the signals coming from the safety light curtain. The filter can be configured to between 3 and 250ms and eliminates any bouncing on the contacts. The length of the filter affects the calculation of the unit's total response time.

Simultaneity (ms): This is only active if the previous parameter is enabled. It defines the maximum time (in msec) between the switching of two different signals from the safety light curtain.

Enable Error Out: If selected reports a fault detected by the function block.

Item Description: This allows a description of the component's function to be entered. The text is displayed in the top part of the symbol.

FOOTSWITCH (safety pedal)

The FOOTSWITCH function block verifies the status of the inputs of a safety pedal device. If the pedal is not pressed the output is 0 (FALSE). Otherwise the output is 1 (TRUE).

Parameters

Input Type:

- Single NC – Allows connection of pedals with one NC contact
- Single NO – Allows connection of pedals with one NO contact.
- Double NC – Allows connection of pedals with two NC contacts
- Double NC/NO – Allows connection of pedals with one NO contact and one NC.

Manual Reset: If selected this enables the request to reset each time the footswitch is activated. Otherwise, enabling of the output directly follows the input conditions.

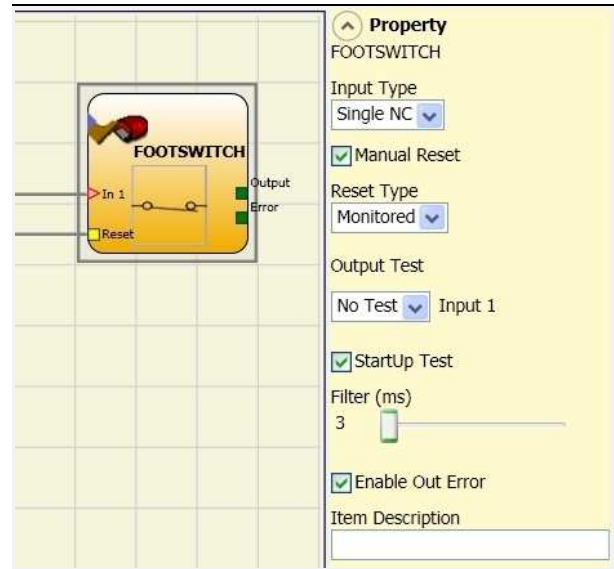

There are two types of reset: Manual and Monitored. When Manual is selected the system only verifies the signal's transition from 0 to 1. If Monitored is selected the double transition from 0 to 1 and then back to 0 is verified.

➔ **WARNING:** If the Manual Reset is active, a consecutive Input has to be used. Ex.: Input 1 and Input 2 are used for the functional block, then Input 3 has to be used for the Reset Input.

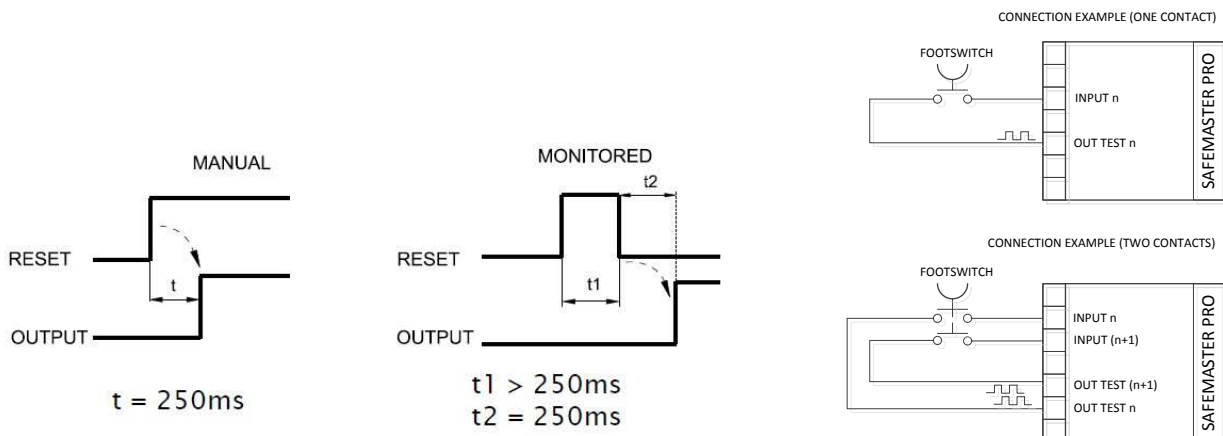

Output Test: This is used to select which test output signals are to be sent to the component contacts. This additional test makes it possible to detect and manage any short-circuits between the lines. There is a choice of up to 8 possible test output signals, Test Output 1 ÷ Test Output 8 (depending on used module).

StartUp Test: If selected this enables the test at start-up of the external component. This test is performed by pressing the pedal to run a complete function test and enable the output. This test is only requested at machine start-up (when the unit is switched on).

Filter (ms): This is used to filter the signals coming from the external contacts. The filter can be configured to between 3 and 250ms and eliminates any bouncing on the contacts. The length of the filter affects the calculation of the unit's total response time.

With Simultaneity: If selected this activates the test to verify simultaneous switching of the signals coming from the external contacts.

Simultaneity (ms): This is only active if the previous parameter is enabled. It defines the maximum time (in msec) between the switching of two different signals from the external contacts.

Enable Error Out: If selected reports a fault detected by the function block.

Item Description: This allows a description of the component's function to be entered. The text is displayed in the top part of the symbol.

MOD-SEL (safety selector)

The MOD-SEL function block verifies the status of the inputs from a mode selector (up to 4 inputs): If only one input is 1 (TRUE) the corresponding output is also 1 (TRUE). In all other cases, and thus when all inputs are 0 (FALSE) or more than one input is 1 (TRUE) all the outputs are 0 (FALSE)

Parameters

Input Type:

- Double selector – Allows connection of two-way mode selectors.
- Triple selector – Allows connection of three-way mode selectors.
- Quadruple selector - Allows connection of four-way mode selectors.

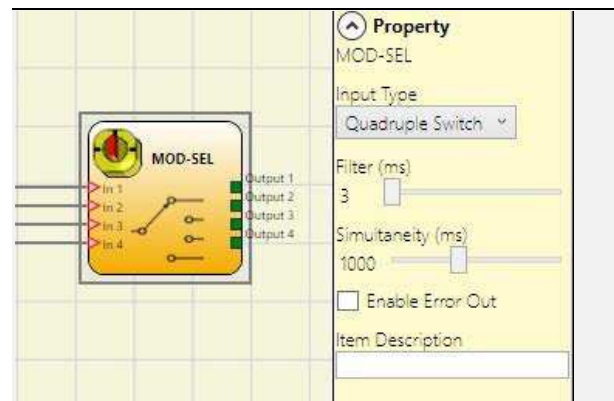

Filter (ms): This is used to filter the signals coming from the mode selector. The filter can be configured to between 3 and 250ms and eliminates any bouncing on the contacts. The length of the filter affects the calculation of the unit's total response time

Enable Error Out: If selected reports a fault detected by the function block.

Simultaneity (ms): always active. Determines the maximum permissible time (ms) between switching of the various signals from the external contacts of the device.

Item Description: This allows a description of the component's function to be entered. The text is displayed in the top part of the symbol.

PHOTOCELL (safety photocell)

The PHOTOCELL function block verifies the status of the inputs of an optoelectronic safety photocell. If the beam of the photocell is occupied (photocell output FALSE) the output is 0 (FALSE). Otherwise with the beam clear and an output of 1 (TRUE) the output is 1 (TRUE).

Parameters

Manual Reset: If selected this enables the request to reset each time the safety photocell is activated. Otherwise, enabling of the output directly follows the input conditions.

There are two types of reset: Manual and Monitored. When Manual is selected the system only verifies the signal's transition from 0 to 1. If Monitored is selected the double transition from 0 to 1 and then back to 0 is verified.

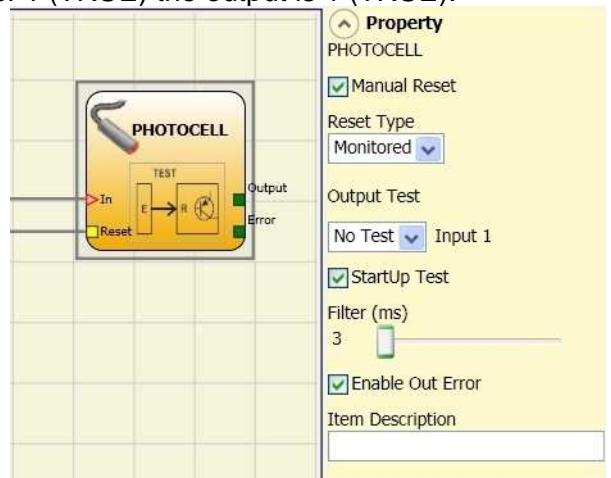

➔ **WARNING:** If the Manual Reset is active, a consecutive Input has to be used. Ex.: Input 1 is used for the functional block, then Input 2 has to be used for the Reset Input.

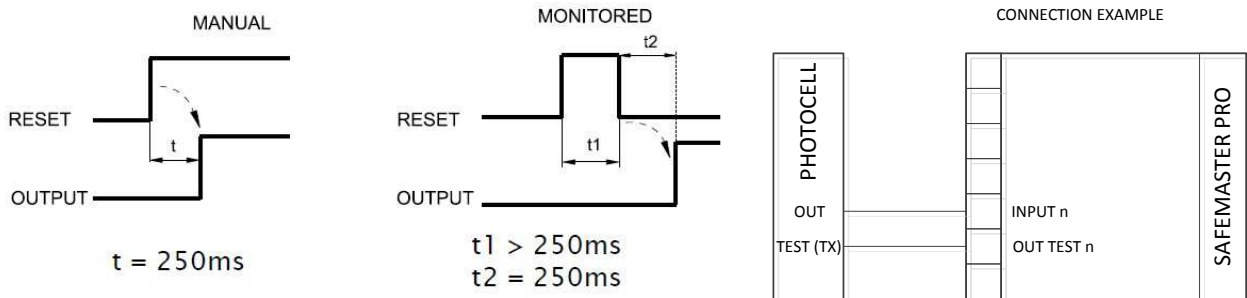

Output Test: This is used to select which test output are to be sent to the photocell test input. This additional test makes it possible to detect and manage any short-circuits between the lines. One test signal is mandatory. There is a choice of up to 8 possible test output signals, Test Output 1 ÷ Test Output 8 (depending on used module).

StartUp Test: If selected this enables the test at start-up of the external component. This test is performed by occupying and clearing the light stream of the safety photocell to run a complete function test and enable the output. This test is only requested at machine start-up (when the unit is switched on).

Filter (ms): This is used to filter the signals coming from the external contacts. The filter can be configured to between 3 and 250ms and eliminates any bouncing on the contacts. The length of the filter affects the calculation of the unit's total response time.

Enable Error Out: If selected reports a fault detected by the function block.

Item Description: This allows a description of the component's function to be entered. The text is displayed in the top part of the symbol.

TWO-HAND (bimanual control)

The TWO HAND function block verifies the status of the inputs of a two hand control switch. Only if both the press-buttons are pressed within 500msec the output is 1 (TRUE). Otherwise the output is 0 (FALSE).

Parameters

Input Type:

- Double INPUT – Allows connection of two-hand switch with one NO contact for each button.
- Quadruple selector - Allows connection of two-hand switch with one NO +one NC contact for each button.

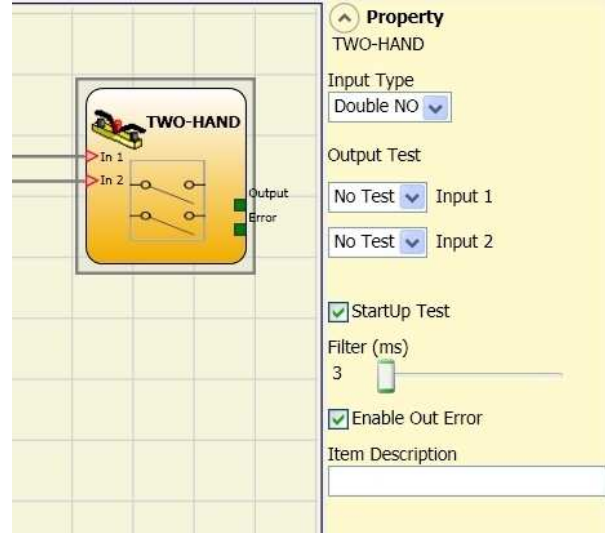

Output Test: This is used to select which test output signals are to be sent to the component contacts. This additional test makes it possible to detect and manage any short-circuits between the lines. There is a choice of up to 8 possible test output signals, Test Output 1 ÷ Test Output 8 (depending on used module).

StartUp Test: If selected this enables the test at start-up of the external component. If this test is enabled, the two buttons must be released before they can be pressed (within 500msec) to run a complete function test and enable the output. This test is only requested at machine start-up (when the unit is switched on).

Filter (ms): This is used to filter the signals coming from the mode selector. The filter can be configured to between 3 and 250ms and eliminates any bouncing on the contacts. The length of the filter affects the calculation of the unit's total response time

Enable Error Out: If selected reports a fault detected by the function block.

Item description: This allows a description of the component's function to be entered. The text is displayed in the top part of the symbol.

SENSOR

The SENSOR function block verifies the status of the input of a sensor (not a safety sensor). If the beam of the sensor is occupied (sensor output FALSE) the output is 0 (FALSE). Otherwise, with the beam clear and an output of 1 (TRUE) then the output is 1 (TRUE).

Parameters

Manual Reset: If selected this enables the request to reset each time the area protected by the sensor is occupied. Otherwise, enabling of the output directly follows the input conditions.

There are two types of reset: Manual and Monitored. When Manual is selected the system only verifies the signal's transition from 0 to 1. If Monitored is selected the double transition from 0 to 1 and then back to 0 is verified.

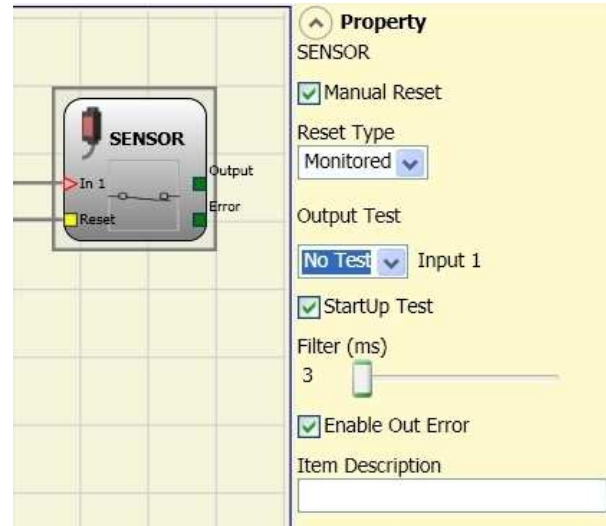

➔ **WARNING:** If the Manual Reset is active, a consecutive Input has to be used. Ex.: Input 1 is used for the functional block, then Input 2 has to be used for the Reset Input.

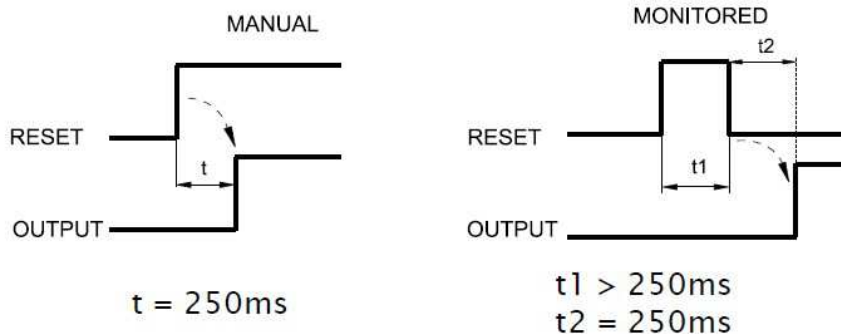

Output Test: This is used to select which test output signals are to be sent to the sensor. This additional test makes it possible to detect and manage any short-circuits between the lines. There is a choice of up to 8 possible test output signals, Test Output 1 ÷ Test Output 8 (depending on used module).

StartUp Test: If selected this enables the test at start-up of the external component. This test is performed by occupying and clearing the area of the sensor to run a complete function test and enable the output. This test is only requested at machine start-up (when the unit is switched on).

Filter (ms): This is used to filter the signals coming from the safety light curtain. The filter can be configured to between 3 and 250ms and eliminates any bouncing on the contacts. The length of the filter affects the calculation of the unit's total response time.

Enable Error Out: If selected reports a fault detected by the function block.

Item Description: This allows a description of the component's function to be entered. The text is displayed in the top part of the symbol.

S-MAT (safety mat)

The S-MAT function block verifies the status of the inputs of a safety mat. If a person stands on the mat the output is 0 (FALSE). Otherwise, with the mat clear, the output is 1 (TRUE)

Parameters

Manual Reset: If selected this enables the request to reset each time the safety mat is activated. Otherwise, enabling of the output directly follows the input conditions.

There are two types of reset: Manual and Monitored. When Manual is selected the system only verifies the signal's transition from 0 to 1. If Monitored is selected the double transition from 0 to 1 and then back to 0 is verified.

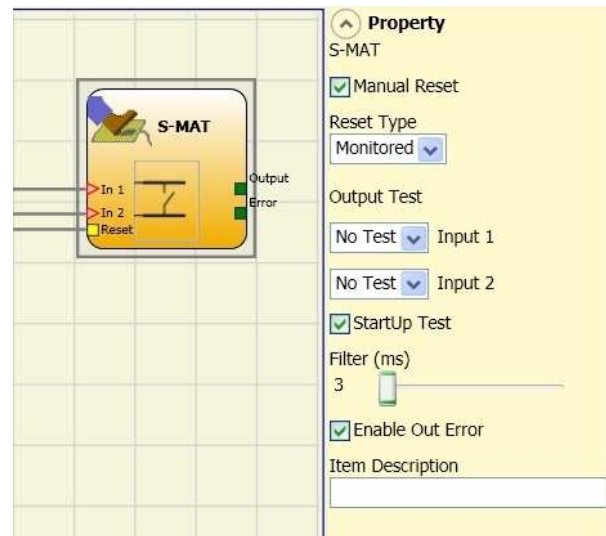

- ➔ If the Manual Reset is active, a consecutive Input has to be used. Example: Input 1 and Input 2 are used for the functional block, then Input 3 has to be used for the Reset Input.
- ➔ Each output OUT TEST connected to one input S-MAT cannot be used for other function blocks (it is not allowed parallel connection of 2 inputs).
- ➔ The function block S-MAT cannot be used with 2-wire components and termination resistance.

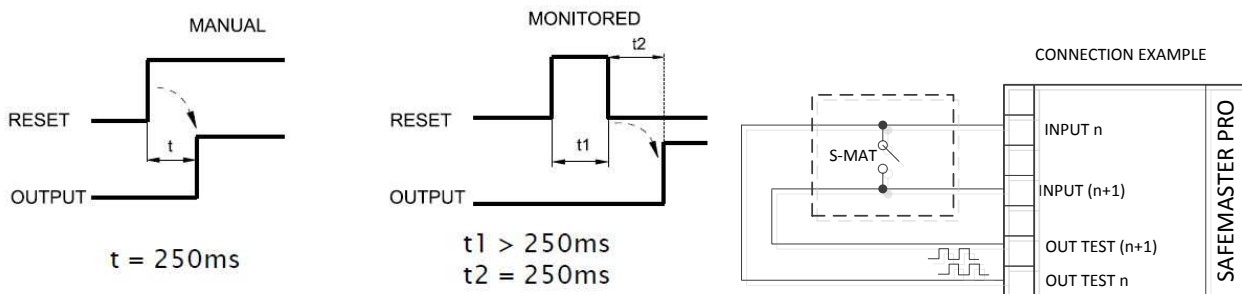

Output Test: Test signals are mandatory. There is a choice of up to 8 possible test output signals, Test Output 1 ÷ Test Output 8 (depending on used module).

Startup Test: If selected this enables the test at start-up of the external component. This test is performed by standing on the S-Mat to run a complete function test and enable the output. This test is only requested at machine start-up (when the unit is switched on).

Filter (ms): This is used to filter the signals coming from the external contacts. The filter can be configured to between 3 and 250ms and eliminates any bouncing on the contacts. The length of the filter affects the calculation of the unit's total response time.

Enable Error Out: If selected reports a fault detected by the function block.

Item Description: This allows a description of the component's function to be entered. The text is displayed in the top part of the symbol.

SWITCH

The SWITCH function block verifies the status of the input of a pushbutton or switch (not safety switches). If the pushbutton is pressed the output is 1 (TRUE). Otherwise, the output is 0 (FALSE).

Parameters

Manual Reset: If selected this enables the request to reset each time the switch is closed. Otherwise, enabling of the output directly follows the input conditions.

There are two types of reset: Manual and Monitored. When Manual is selected the system only verifies the signal's transition from 0 to 1. If Monitored is selected the double transition from 0 to 1 and then back to 0 is verified.

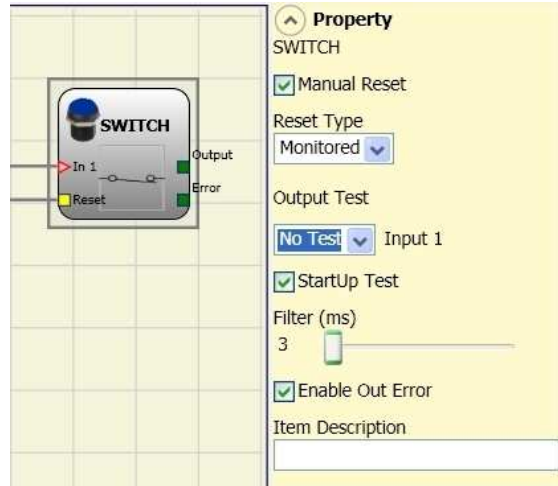

➔ **WARNING:** If the Manual Reset is active, a consecutive Input has to be used. Ex.: Input 1 is used for the functional block, then Input 2 has to be used for the Reset Input.

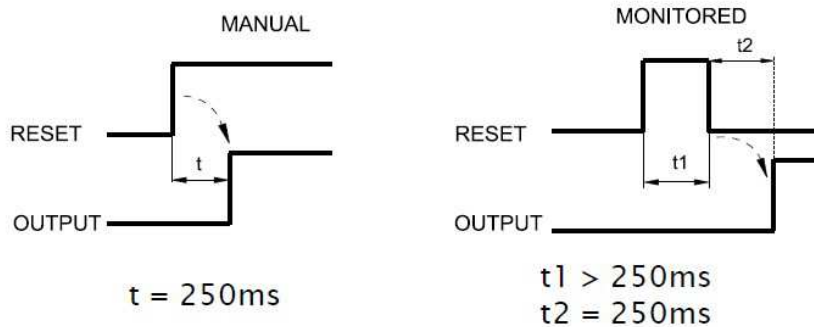

Output Test: This is used to select which test output signals are to be sent to the emergency stop (mushroom pushbutton). This additional test makes it possible to detect and manage any short-circuits between the lines. There is a choice of up to 8 possible test output signals, Test Output 1 ÷ Test Output 8 (depending on used module).

StartUp Test: If selected this enables the test at start-up of the external component. This test is performed by release the switch before it can be pressed to run a complete function test and enable the output. This test is only requested at machine start-up (when the unit is switched on).

Filter (ms): This is used to filter the signals coming from the safety light curtain. The filter can be configured to between 3 and 250ms and eliminates any bouncing on the contacts. The length of the filter affects the calculation of the unit's total response time.

Enable Error Out: If selected reports a fault detected by the function block.

Item Description: This allows a description of the component's function to be entered. The text is displayed in the top part of the symbol.

ENABLING GRIP SWITCH

The ENABLING GRIP functional block checks the status of the In_x inputs of an enabling grip. If this is not gripped (position 1) or is gripped completely (position 3), the OUTPUT will be 0 (FALSE). If it is gripped to middle position (position 2), the OUTPUT will be 1 (TRUE). Refer to truth tables at the bottom of the page.

➔ **NOTE:** The ENABLING GRIP functional block requires that the assigned module has a minimum Firmware version as Table below:

UG6911	UG6916	UG6913.08	UG6913.16	UG6913.12
1.0	0.4	0.4	0.4	0.0

Parameters

Type of inputs:

- Double NO – Permits connection of an enabling grip with 2 NO contacts.
- Double NO+1NC – Permits connection of an enabling grip switch with 2 NO contacts + 1 NC contact.

Manual Reset: If selected, enables the reset request after each activation of the device. Otherwise, enabling of the output follows directly the conditions of the inputs.

Reset may be of two types: Manual and Monitored. Selecting the Manual option, only transition of the signal from 0 to 1 is checked. If Monitored is selected, double transition from 0 to 1 and return to 0 is checked.

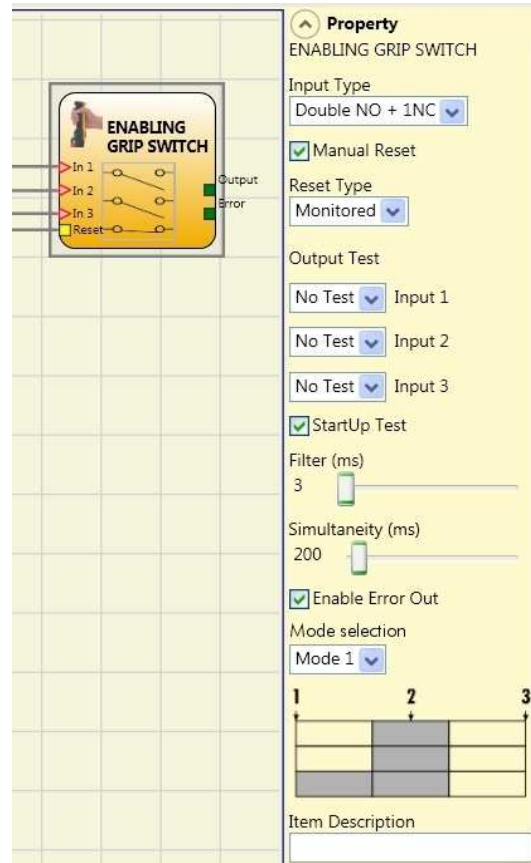

➔ **WARNING:** if Manual Reset is enabled, the input consecutive to those used by the functional block must be used. For example: If inputs 1 and 2 are used for the functional block, input 3 must be used for Reset.

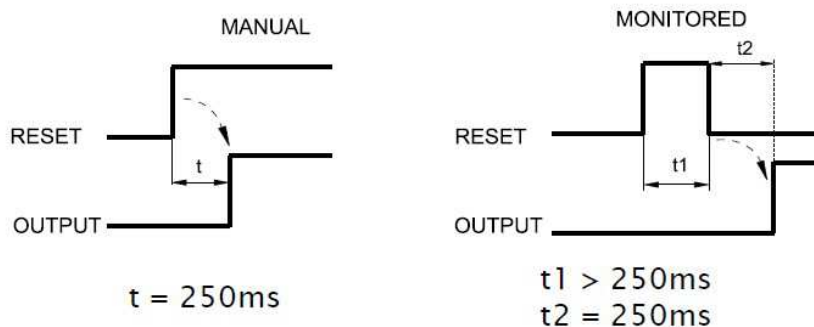

Test outputs: Permits selection of the test output signals to be sent to the enabling grip. This additional control permits detection and management of any short-circuits between the lines. To enable this control, the test output signals must be configured (amongst those available).

StartUp test: If selected, enables the power-on test of the external component (Enabling Grip). To run the test, the device must be gripped and released to carry out a complete functional check and enable the Output terminal. This control is required only at machine start-up (power-on of the module).

Simultaneity (ms): always active. Determines that maximum permissible time (msec) between switching of the various signals from the external contacts of the device.

Filter (ms): Permits filtering of signals from the device control. This filter can be set to between 3 and 250ms and eliminates any rebounds on the contacts. The duration of the filter affects calculation of module total response time.

Enable Error Out: If selected reports a fault detected by the function block.

Item description: Permits insertion of a descriptive text of the function of the component. This text will be displayed in the top part of the symbol.

Table mode 1 (device 2NO + 1NC)

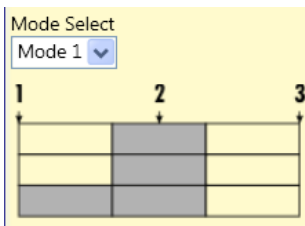

POSITION 1: enabling grip fully released
 POSITION 2: enabling grip pressed to middle position
 POSITION 3: enabling grip fully pressed

Input	Position		
	1	2	3
IN1	0	1	0
IN2	0	1	0
IN3	1	1	0
OUT	0	1	0

(only with 2NO+1NC)

Table mode 1 (device 2NO + 1NC)

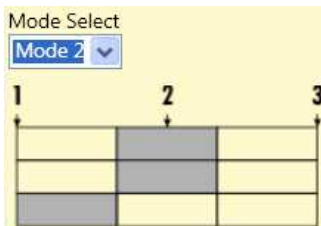

POSITION 1: enabling grip fully released
 POSITION 2: enabling grip pressed to middle position
 POSITION 3: enabling grip fully pressed

Input	Position		Input	1
	1	Input		
IN1	0	1	0	0
IN2	0	1	0	0
IN3	1	0	0	0
OUT	0	1	0	0

(only with 1NO+1NC)

TESTABLE SAFETY DEVICE

The TESTABLE SAFETY DEVICE functional block checks the status of the Inx inputs of a single or double safety sensor, both NO and NC. Refer to the tables below to check type of sensor and behavior.

Parameters

Manual Reset: If selected, enables the reset request after each activation of the device. Otherwise, enabling of the output follows directly the conditions of the inputs.

Reset may be of two types: Manual and Monitored. Selecting the Manual option, only transition of the signal from 0 to 1 is checked. If Monitored is selected, double transition from 0 to 1 and return to 0 is checked.

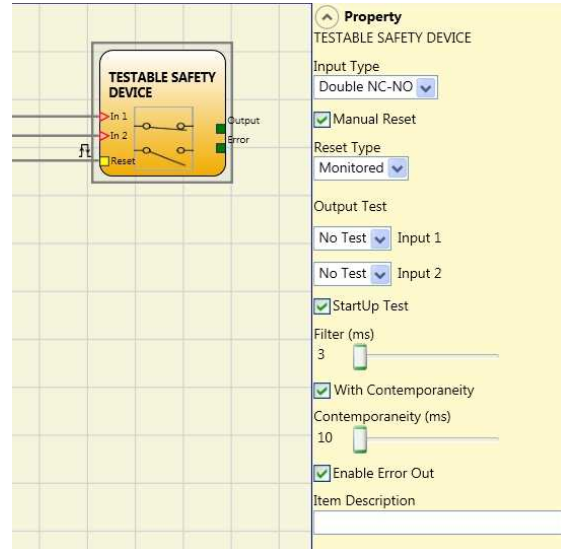

(single NC)



IN1	OUT
0	0
1	1

(single NO)

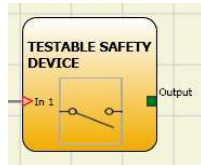

IN1	OUT
0	0
1	1

(double NC)



IN1	IN2	OUT	Simultaneity error *
0	0	0	-
0	1	0	X
1	0	0	X
1	1	1	-

(double NC-NO)

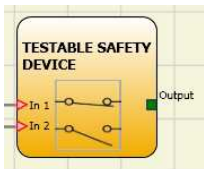

IN1	IN2	OUT	Simultaneity error *
0	0	0	X
0	1	0	-
1	0	1	-
1	1	0	X

* **Simultaneity error** = the max. time between switching of the single contacts has been exceeded.

➔ **WARNING:** if Reset is enabled, the input consecutive to those used by the functional block must be used. For example: If inputs 1 and 2 are used for the functional block, input 3 must be used for Reset.

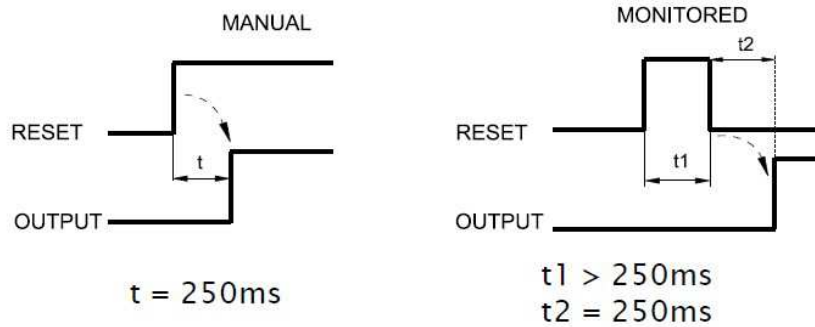

Test outputs: Permits selection of the test output signals to be sent to the contacts. This additional control permits detection and management of any short-circuits between the lines. To enable this control, the test output signals must be configured (amongst those available).

StartUp test: If selected, enables the power-on test of the device. This test requires activation and de-activation of the device in order to run a complete functional check and enable the Output terminal. This test is required only at machine start-up (power-on of the module).

Filter (ms): Permits filtering of signals from the device. This filter can be set to between 3 and 250ms and eliminates any rebounds on the contacts. The duration of the filter affects calculation of module total response time.

With Simultaneity: If selected, activates control of simultaneity between switching of signals from the device.

Simultaneity (ms): Is active only if the previous parameter is enabled. Determines the maximum permissible time (msec) between switching of two different signals from the sensor.

Enable Error Out: If selected reports a fault detected by the function block.

Item description: Permits insertion of a descriptive text of the function of the component. This text will be displayed in the top part of the symbol.

SOLID STATE DEVICE

The SOLID STATE DEVICE functional block checks the status of the Inx inputs. If the inputs are at 24VDC, the Output will be 1 (TRUE), otherwise the OUTPUT will be 0 (FALSE).

Parameters

Manual Reset: If selected, enables the reset request after each occupation of the area protected by the light curtain. Otherwise, enabling of the output follows directly the conditions of the inputs.

Reset may be of two types: Manual and Monitored. Selecting the Manual option, only transition of the signal from 0 to 1 is checked. If Monitored is selected, double transition from 0 to 1 and return to 0 is checked.

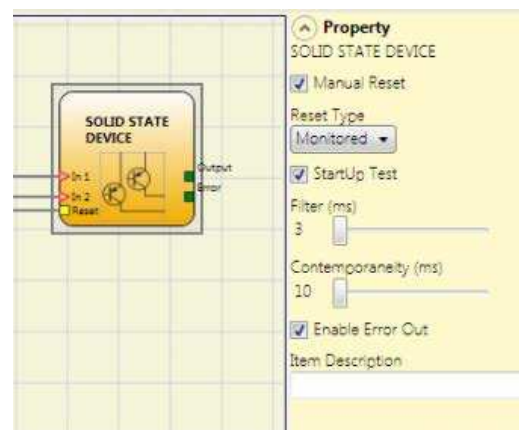

➔ **WARNING:** if Reset is enabled, the input consecutive to those used by the functional block must be used. For example: If inputs 1 and 2 are used for the functional block, input 3 must be used for Reset.

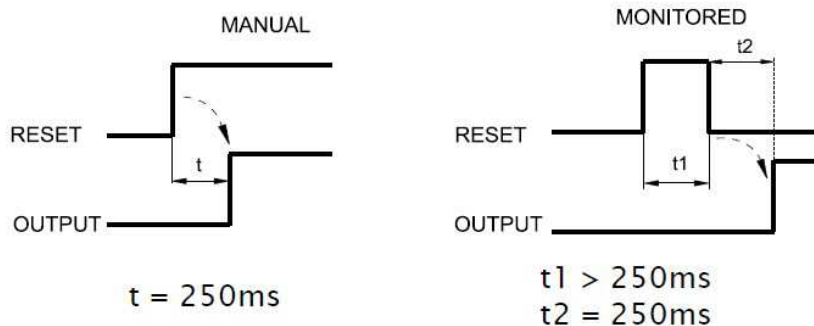

StartUp test: If selected, enables the power-on test of the safety device. This test requires activation and de-activation of the device in order to run a complete functional check and enable the Output terminal. This test is required only at machine start-up (power-on of the module)

Filter (ms): Permits filtering of signals from the safety device. This filter can be set to between 3 and 250ms and eliminates any rebounds on the contacts. The duration of the filter affects calculation of module total response time.

Simultaneity (ms): Determines that maximum permissible time (msec) between switching of two different signals from the device.

Enable Error Out: If selected reports a fault detected by the function block.

Item description: Permits insertion of a descriptive text of the function of the component. This text will be displayed in the top part of the symbol.

FIELDBUS INPUT

Element that permits insertion of a non-safety input whose status is modified via the fieldbus. Up to 8 virtual inputs can be inserted and the bit on which status is to be modified must be selected for each.

They are represented with one byte on the fieldbus.

(For more detailed information, consult the fieldbus manual on the SAFEMASTER PRO Designer CD-ROM).

Parameters

Item description: Permits insertion of a descriptive text of the function of the component. This text will be displayed in the top part of the symbol.

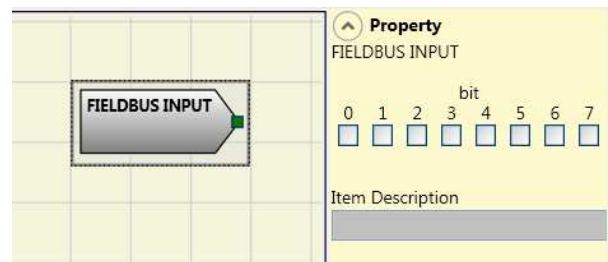

 **WARNING:** the FIELDBUS INPUT is NOT a safety input.

LLO, LL1

These allow a predefined logical level to be entered on a component's input.

LL0 -> logical level 0

LL1 -> logical level 1

IMPORTANT: LL0 and LL1 cannot be used to disable the logical operators (AND, OR, XOR ...) in the diagram



NETWORK IN

This functional block implements a Network connection input interface; it generates an LL1 in the OUT output when the line is high, otherwise an LL0.

Parameters

Type of Input:

- Single: enables the connection of signalling outputs of an additional UG6911 unit
- Double: enables the connection of OSSD outputs of an additional UG6911 unit

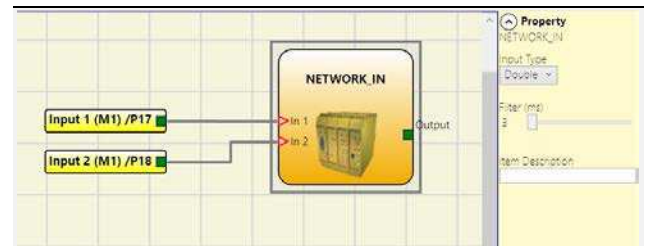

Filter (ms): Enables the filtering of signals from an additional UG6911 unit. This filter can be set to between 3 and 250 ms. The length of the filter affects the calculation of the unit's total response time.

This input can only be allocated on UG6911. This input must be used when UG6911 OSSD outputs are connected to the inputs of a second downstream UG6911 or together with the NETWORK operator.

SPEED CONTROL TYPE FUNCTION BLOCKS

SPEED CONTROL

The Speed Control function block monitors the speed of a device generating an output 0 (FALSE) when the measured speed exceeds a predetermined threshold. In the case in which the speed is below the predetermined threshold the output will be 1 (TRUE).

Parameters

Axis type: It defines the type of axis controlled by the device. It will be Linear in the case of a translation and will be Rotary in the case of motion around an axis.

Sensor Type: In the event that the previous parameter is Linear, the Sensor Type defines the type of sensor connected to the module inputs. It can be Rotary (e.g. shaft encoder) or Linear (e.g. optical array). This choice allows to define the following parameters.

Measuring device: It defines the type of sensor(s) used. The possible choices are:

- Encoder
- Proximity
- Encoder + Proximity
- Proximity1 + Proximity2
- Encoder1 + Encoder2

Enable direction: Enabling this parameter, the DIR output is enabled on the function block. This output will be 1 (TRUE) when the axis rotates Counterclockwise and will be 0 (FALSE) when the axis rotates Clockwise

Direction decision: It defines the direction of rotation for which the set thresholds are made active. The possible choices are:

- Bidirectional
- Clockwise
- Counterclockwise

If Bidirectional is selected, the excess of the set threshold is detected whether the axis rotates clockwise or counterclockwise. Selecting Clockwise or Counterclockwise, this is detected only when the axis rotates in the selected direction.

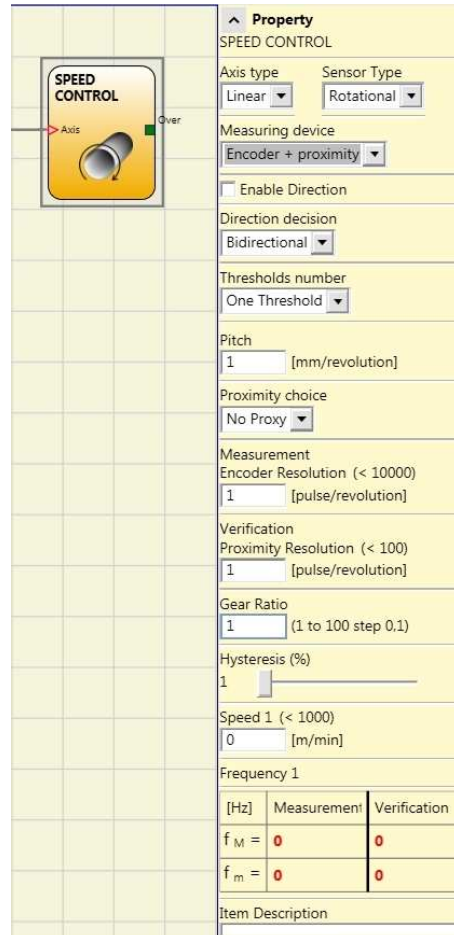

Example of CLOCKWISE axis rotation

2 threshold settings

In1	Threshold no.
0	Speed 1
1	Speed 2

4 threshold settings

In2	In1	Threshold no.
0	0	Speed 1
0	1	Speed 2
1	0	Speed 3
1	1	Speed 4

Threshold number: It allows you to enter the number of thresholds for the maximum value of speed. Changing this value will increase/decrease the number of thresholds that can be entered from a minimum of 1 to a maximum of 4. In the case of thresholds greater than 1, the input pins for the selection of the specific *Pitch*: If the Axis Type chosen was linear, this field allows you to enter the sensor pitch to obtain a conversion between sensor revolutions and distance travelled.

Proximity choice: It allows you to choose the type of proximity sensor from PNP, NPN, Normally Open (NO) and Normally Closed (NC), with 3 or 4 wires.

(In order to ensure a Performance Level = PLe use a proximity switch type PNP, NO)

Proximity Interleaved: When an axis of the UG 6917 module is configured for a measurement with two proximity switches, these can be configured in interleaved mode. Under the conditions listed below the system reaches a Performance Level = PLe:

- Proximity switches must be fitted such that the recorded signals overlap.
- Proximity switches must be fitted such that at least one is always activated.

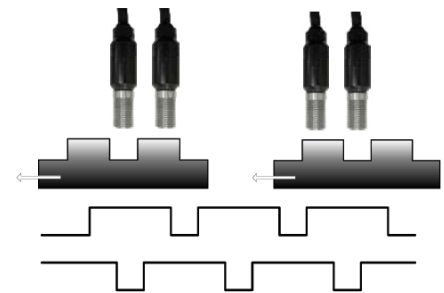

Measurement: Enter in this field the number of pulses/revolution (in the case of rotary sensor) or $\mu\text{m}/\text{pulse}$ (linear sensor) relating to the sensor used

Verification: Enter in this field the number of pulses/revolution (in the case of rotary sensor) or $\mu\text{m}/\text{pulse}$ (linear sensor) relating to the second sensor used.

Gear Ratio: This parameter is active if there are two sensors on the selected axis. This parameter allows you to enter the ratio between the two sensors. If both sensors are on the same moving parts, the ratio will be 1 otherwise the number corresponding to the report must be entered. E.g. there are an encoder and a proximity switch, and the latter is on a moving part that (due to a gear reduction ratio) rotates at twice the speed of the encoder. Therefore, this value must be set at 2.

Hysteresis (%): It represents the percentage hysteresis value below which the speed change is filtered. Enter a value other than 1 to avoid continuous switching as the input changes.

Speed 1, 2, 3, 4: Enter in this field the maximum speed value above which the function block output (OVER) will be 0 (FALSE). If the measured speed is less than the set value, the function block output (OVER) will be 1 (TRUE).

Frequency: It shows the maximum calculated frequency values f_M and f_m (decreased by the hysteresis set). If the displayed value is GREEN, the calculation of frequency gave a positive result.

If the displayed value is RED, it is necessary to change the parameters given in the following formulas.

Rotary axis, rotary sensor. The frequency obtained is:

$$f[\text{Hz}] = \frac{\text{rpm}[\text{rev}/\text{min}]}{60} * \text{Resolution}[\text{pulses}/\text{rev}]$$

Linear axis, rotary sensor. The frequency obtained is:

$$f[\text{Hz}] = \frac{\text{speed}[\text{m}/\text{min}] * 1000}{60 * \text{pitch}[\text{mm}/\text{rev}]} * \text{Resolution}[\text{pulses}/\text{rev}]$$

KEY:*f = frequency**Rpm = rotational speed**Resolution = measurement**Speed = linear speed**Pitch = sensor pitch*

Linear axis, linear sensor. The frequency obtained is:

$$f[\text{Hz}] = \frac{\text{speed}[\text{mm}/\text{s}] * 1000}{\text{Resolution}[\mu\text{m}/\text{pulse}]}$$

Hysteresis. To be changed only if: fM=green; fm=red

WINDOW SPEED CONTROL

The Window Speed Control function block monitors the speed of a device, generating the Zero to 1 (TRUE) output when the speed is within a prefixed range.

Parameters

Axis type: It defines the type of axis controlled by the device. It will be Linear in the case of a translation and will be Rotary in the case of motion around an axis.

Sensor Type: In the event that the previous parameter is Linear, the Sensor Type defines the type of sensor connected to the module inputs. It can be Rotary (e.g. shaft encoder) or Linear (e.g. optical array). This choice allows to define the following parameters.

Measuring device: It defines the type of sensor(s) used. The possible choices are:

- Encoder
- Proximity
- Encoder + Proximity
- Proximity1 + Proximity2
- Encoder1 + Encoder2

Pitch: If the Axis Type chosen was linear, this field allows you to enter the sensor pitch to obtain a conversion between sensor revolutions and distance travelled.

Proximity choice: It allows you to choose the type of proximity sensor from PNP, NPN, Normally Open (NO) and Normally Closed (NC), with 3 or 4 wires.

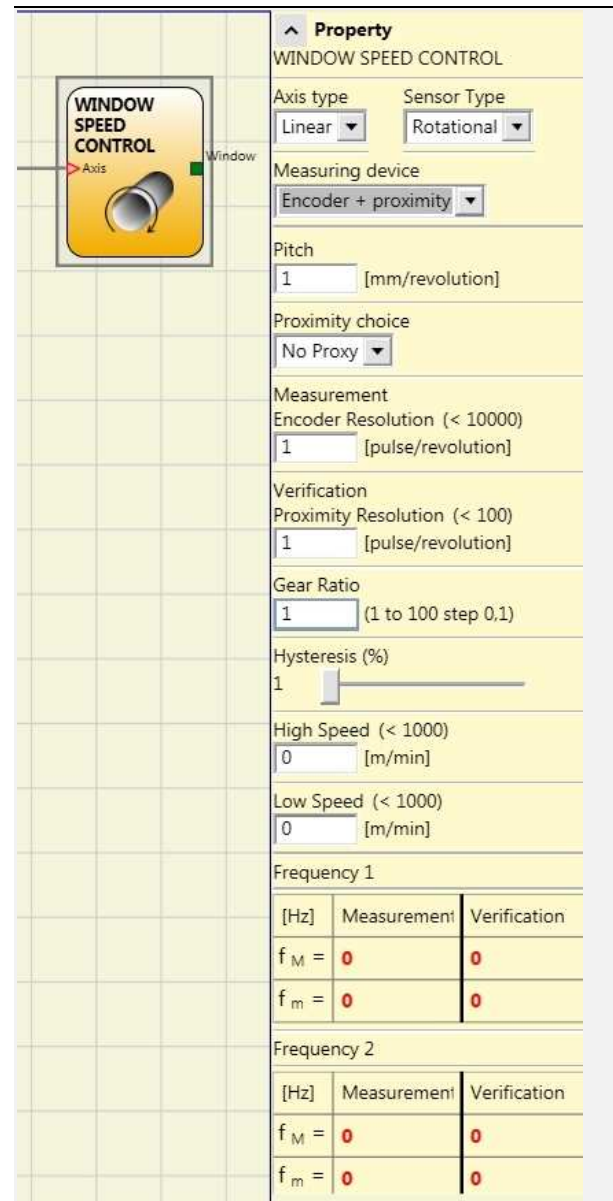

Property
WINDOW SPEED CONTROL

Axis type: Linear | Sensor Type: Rotational

Measuring device: Encoder + proximity

Pitch: 1 [mm/revolution]

Proximity choice: No Proxy

Measurement: Encoder Resolution (< 10000) 1 [pulse/revolution]

Verification: Proximity Resolution (< 100) 1 [pulse/revolution]

Gear Ratio: 1 (1 to 100 step 0,1)

Hysteresis (%): 1

High Speed (< 1000) 0 [m/min]

Low Speed (< 1000) 0 [m/min]

Frequency 1		
[Hz]	Measurement	Verification
$f_M = 0$		0
$f_m = 0$		0

Frequency 2		
[Hz]	Measurement	Verification
$f_M = 0$		0
$f_m = 0$		0

(In order to ensure a Performance Level = PLe use a proximity switch type PNP, NO)

Proximity Interleaved: When an axis of the UG 6917 module is configured for a measurement with two proximity switches, these can be configured in interleaved mode. Under the conditions listed below the system reaches a Performance Level = PLe:

- Proximity switches must be fitted such that the recorded signals overlap.
- Proximity switches must be fitted such that at least one is always activated.

Measurement: Enter in this field the number of pulses/revolution

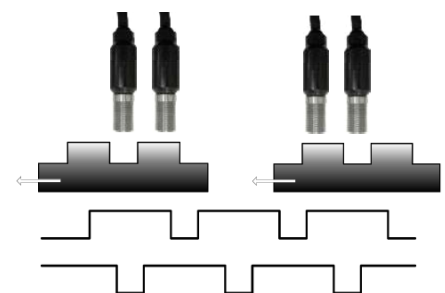

(in the case of rotary sensor) or $\mu\text{m}/\text{pulse}$ (linear sensor) relating to the sensor used.

Verification: Enter in this field the number of pulses/revolution (in the case of rotary sensor) or $\mu\text{m}/\text{pulse}$ (linear sensor) relating to the second sensor used.

Gear Ratio: This parameter is active if there are two sensors on the selected axis. This parameter allows you to enter the ratio between the two sensors. If both sensors are on the same moving parts, the ratio will be 1 otherwise the number corresponding to the report must be entered. E.g. there are an encoder and a proximity switch, and the latter is on a moving part that (due to a gear reduction ratio) rotates at twice the speed of the encoder. Therefore, this value must be set at 2.

Hysteresis (%): It represents the percentage hysteresis value below which the speed change is filtered. Enter a value other than 1 to avoid continuous switching as the input changes.

High speed: Enter in this field the maximum speed value above which the output of the function block (WINDOW) will be 0 (FALSE). If the measured speed is less than the set value, the output (WINDOW) of the function block will be 1 (TRUE).

Low speed: Enter in this field the minimum speed value below which the output of the function block (WINDOW) will be 0 (FALSE). If the measured speed is more than the set value, the output (WINDOW) of the function block will be 1 (TRUE).

Frequency: It shows the maximum calculated frequency values f_M and f_m (decreased by the hysteresis set). If the displayed value is GREEN, the calculation of frequency gave a positive result.

If the displayed value is RED, it is necessary to change the parameters given in the following formulas.

Rotary axis, rotary sensor. The frequency obtained is:

$$f[\text{Hz}] = \frac{\text{rpm}[\text{rev}/\text{min}]}{60} * \text{Resolution}[\text{pulses}/\text{rev}]$$

Linear axis, rotary sensor. The frequency obtained is:

$$f[\text{Hz}] = \frac{\text{speed}[\text{m}/\text{min}] * 1000}{60 * \text{pitch}[\text{mm}/\text{rev}]} * \text{Resolution}[\text{pulses}/\text{rev}]$$

KEY:

f = frequency
Rpm = rotational speed
Resolution = measurement
Speed = linear speed
Pitch = sensor pitch

Linear axis, linear sensor. The frequency obtained is:

$$f[\text{Hz}] = \frac{\text{speed}[\text{mm}/\text{s}] * 1000}{\text{Resolution}[\mu\text{m}/\text{pulse}]}$$

Hysteresis. To be changed only if: f_M =green; f_m =red

STAND STILL

The Stand Still function block monitors the speed of a device, generating the Zero to 1 (TRUE) output when the speed is lower than a selected value.

Parameters

Axis type: It defines the type of axis controlled by the device. It will be Linear in the case of a translation and will be Rotary in the case of motion around an axis.

Sensor Type: In the event that the previous parameter is Linear, the Sensor Type defines the type of sensor connected to the module inputs. It can be Rotary (e.g. shaft encoder) or Linear (e.g. optical array). This choice allows to define the following parameters.

Measuring device: It defines the type of sensor(s) used. The possible choices are:

- Encoder
- Proximity
- Encoder + Proximity
- Proximity1 + Proximity2
- Encoder1 + Encoder2

Pitch: If the Axis Type chosen was linear, this field allows you to enter the sensor pitch to obtain a conversion between sensor revolutions and distance travelled.

Proximity choice: It allows you to choose the type of proximity sensor from PNP, NPN, Normally Open (NO) and Normally Closed (NC), with 3 or 4 wires.

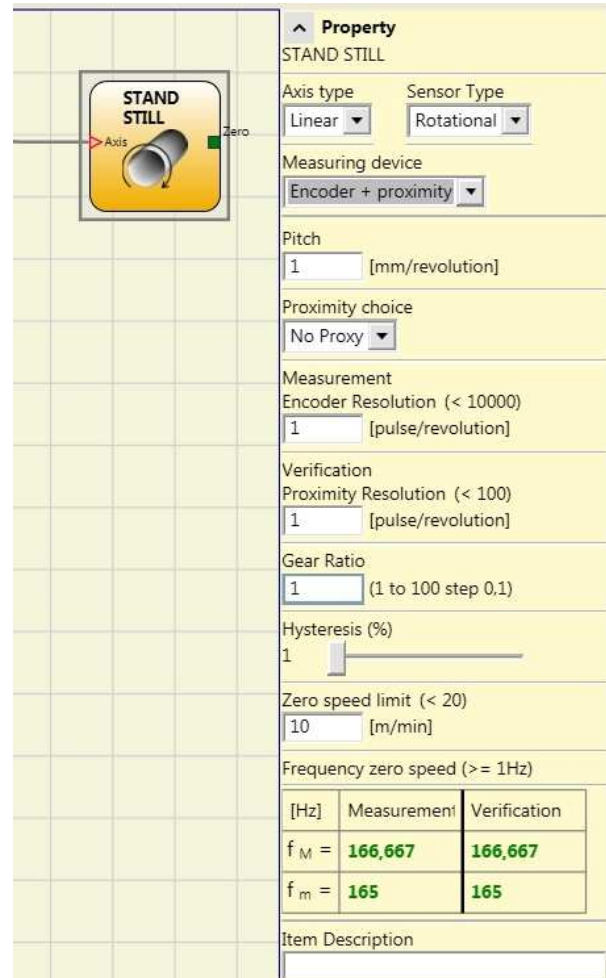

Property
STAND STILL

Axis type: Linear | Sensor Type: Rotational

Measuring device: Encoder + proximity

Pitch: 1 [mm/revolution]

Proximity choice: No Proxy

Measurement

Encoder Resolution (< 10000): 1 [pulse/revolution]

Verification

Proximity Resolution (< 100): 1 [pulse/revolution]

Gear Ratio: 1 (1 to 100 step 0,1)

Hysteresis (%): 1

Zero speed limit (< 20): 10 [m/min]

Frequency zero speed (>= 1Hz)

[Hz]	Measurement	Verification
$f_M =$	166,667	166,667
$f_m =$	165	165

Item Description

(In order to ensure a Performance Level = PLe use a proximity switch type PNP, NO)

Proximity Interleaved: When an axis of the UG 6917 module is configured for a measurement with two proximity switches, these can be configured in interleaved mode. Under the conditions listed below the system reaches a Performance Level = PLe:

- Proximity switches must be fitted such that the recorded signals overlap.
- Proximity switches must be fitted such that at least one is always activated.

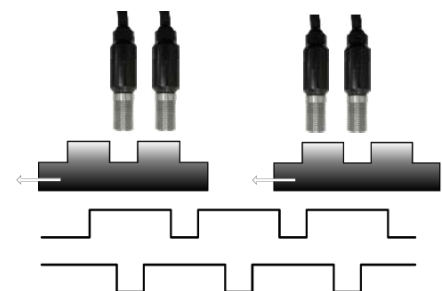

Measurement: Enter in this field the number of pulses/revolution (in the case of rotary sensor) or $\mu\text{m}/\text{pulse}$ (linear sensor) relating to the sensor used

Verification: Enter in this field the number of pulses/revolution (in the case of rotary sensor) or $\mu\text{m/pulse}$ (linear sensor) relating to the second sensor used.

Gear Ratio: This parameter is active if there are two sensors on the selected axis. This parameter allows you to enter the ratio between the two sensors. If both sensors are on the same moving parts, the ratio will be 1 otherwise the number corresponding to the report must be entered. E.g. there are an encoder and a proximity switch, and the latter is on a moving part that (due to a gear reduction ratio) rotates at twice the speed of the encoder. Therefore, this value must be set at 2.

Hysteresis (%): It represents the percentage hysteresis value below which the speed change is filtered. Enter a value other than 1 to avoid continuous switching as the input changes.

Zero speed limit: Enter in this field the maximum speed value above which the output of the function block (ZERO) will be 0 (FALSE). If the measured speed is less than the set value, the output (ZERO) of the function block will be 1 (TRUE).

Frequency zero speed: It shows the maximum calculated frequency values f_M and f_m (decreased by the hysteresis set). If the displayed value is GREEN, the calculation of frequency gave a positive result.
If the displayed value is RED, it is necessary to change the parameters given in the following formulas.

Rotary axis, rotary sensor. The frequency obtained is:

$$f[\text{Hz}] = \frac{\text{rpm}[\text{rev}/\text{min}]}{60} * \text{Resolution}[\text{pulses}/\text{rev}]$$

Linear axis, rotary sensor. The frequency obtained is:

$$f[\text{Hz}] = \frac{\text{speed}[\text{m}/\text{min}] * 1000}{60 * \text{pitch}[\text{mm}/\text{rev}]} * \text{Resolution}[\text{pulses}/\text{rev}]$$

KEY:

f = frequency
Rpm = rotational speed
Resolution = measurement
Speed = linear speed
Pitch = sensor pitch

Linear axis, linear sensor. The frequency obtained is:

$$f[\text{Hz}] = \frac{\text{speed}[\text{mm}/\text{s}] * 1000}{\text{Resolution}[\mu\text{m}/\text{pulse}]}$$

Hysteresis. To be changed only if: f_M =green; f_m =red

STAND STILL AND SPEED CONTROL

The Stand Still and Speed Control function block monitors the speed of a device, generating the Zero to 1 (TRUE) output when the speed is lower than a selected value. In addition, it generates the Over = 0 (FALSE) output if the measured speed exceeds a predetermined threshold.

Parameters

Axis type: It defines the type of axis controlled by the device. It will be Linear in the case of a translation and will be Rotary in the case of motion around an axis.

Sensor Type: In the event that the previous parameter is Linear, the Sensor Type defines the type of sensor connected to the module inputs. It can be Rotary (e.g. shaft encoder) or Linear (e.g. optical array). This choice allows to define the following parameters.

Measuring device: It defines the type of sensor(s) used. The possible choices are:

- Encoder
- Proximity
- Encoder + Proximity
- Proximity1 + Proximity2
- Encoder1 + Encoder2

Enable direction: Enabling this parameter, the DIR output is enabled on the function block. This output will be 1 (TRUE) when the axis rotates Counterclockwise and will be 0 (FALSE) when the axis rotates Clockwise.

Direction decision: It defines the direction of rotation for which the set thresholds are made active. The possible choices are:

- Bidirectional
- Clockwise
- Counterclockwise

If Bidirectional is selected, the excess of the set threshold is detected whether the axis rotates clockwise or counterclockwise. Selecting Clockwise or Counterclockwise, this is detected only when the axis rotates in the selected direction.

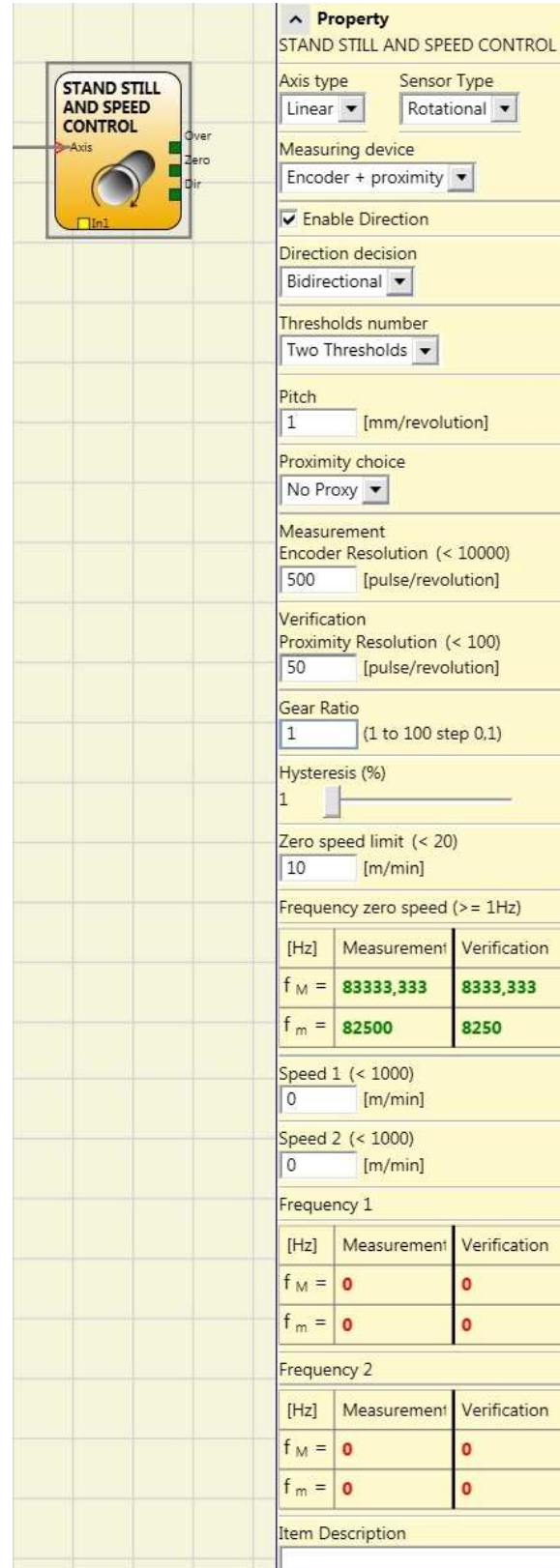

Property
STAND STILL AND SPEED CONTROL

Axis type: Linear | Sensor Type: Rotational

Measuring device: Encoder + proximity

Enable Direction

Direction decision: Bidirectional

Thresholds number: Two Thresholds

Pitch: 1 [mm/revolution]

Proximity choice: No Proxy

Measurement
Encoder Resolution (< 10000): 500 [pulse/revolution]

Verification
Proximity Resolution (< 100): 50 [pulse/revolution]

Gear Ratio: 1 (1 to 100 step 0,1)

Hysteresis (%): 1

Zero speed limit (< 20): 10 [m/min]

Frequency zero speed (>= 1Hz)

[Hz]	Measurement	Verification
$f_M =$	83333,333	8333,333
$f_m =$	82500	8250

Speed 1 (< 1000): 0 [m/min]

Speed 2 (< 1000): 0 [m/min]

Frequency 1

[Hz]	Measurement	Verification
$f_M =$	0	0
$f_m =$	0	0

Frequency 2

[Hz]	Measurement	Verification
$f_M =$	0	0
$f_m =$	0	0

Item Description

Threshold number: It allows you to enter the number of thresholds for the maximum value of speed. Changing this value will increase/decrease the number of thresholds that can be entered from a minimum of 1 to a maximum of 4. In the case of thresholds greater than 1, the input pins for the selection of the specific threshold will appear in the lower part of the function block.

Pitch: If the Axis Type chosen was linear, this field allows you to enter the sensor pitch to obtain a conversion between sensor revolutions and distance travelled.

Proximity choice: It allows you to choose the type of proximity sensor from PNP, NPN, Normally Open (NO) and Normally Closed (NC), with 3 or 4 wires.



Example of CLOCKWISE axis rotation

2 threshold settings

In1	Threshold no.
0	Speed 1
1	Speed 2

4 threshold settings

In2	In1	Threshold no.
0	0	Speed 1
0	1	Speed 2
1	0	Speed 3
1	1	Speed 4

Proximity Interleaved: When an axis of the UG 6917 module is configured for a measurement with two proximity switches, these can be configured in interleaved mode. Under the conditions listed below the system reaches a Performance Level = PLe:

- Proximity switches must be fitted such that the recorded signals overlap.
- Proximity switches must be fitted such that at least one is always activated.

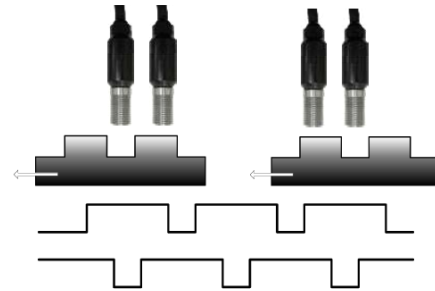

Measurement: Enter in this field the number of pulses/revolution (in the case of rotary sensor) or $\mu\text{m}/\text{pulse}$ (linear sensor) relating to the sensor used

Verification: Enter in this field the number of pulses/revolution (in the case of rotary sensor) or $\mu\text{m}/\text{pulse}$ (linear sensor) relating to the second sensor used.

Gear Ratio: This parameter is active if there are two sensors on the selected axis. This parameter allows you to enter the ratio between the two sensors. If both sensors are on the same moving parts, the ratio will be 1 otherwise the number corresponding to the report must be entered. E.g. there are an encoder and a proximity switch, and the latter is on a moving part that (due to a gear reduction ratio) rotates at twice the speed of the encoder. Therefore, this value must be set at 2.

Hysteresis (%): It represents the percentage hysteresis value below which the speed change is filtered. Enter a value other than 1 to avoid continuous switching as the input changes.

Zero speed limit: Enter in this field the maximum speed value above which the output of the function block (ZERO) will be 0 (FALSE). If the measured speed is less than the set value, the output (ZERO) of the function block will be 1 (TRUE).

Speed 1, 2, 3, 4: Enter in this field the maximum speed value above which the function block output (OVER) will be 0 (FALSE). If the measured speed is less than the set value, the function block output (OVER) will be 1 (TRUE).

Frequency: It shows the maximum calculated frequency values f_M and f_m (decreased by the hysteresis set). If the displayed value is GREEN, the calculation of frequency gave a positive result. If the displayed value is RED, it is necessary to change the parameters given in the following formulas.

Rotary axis, rotary sensor. The frequency obtained is:

$$f[\text{Hz}] = \frac{\text{rpm}[\text{rev}/\text{min}]}{60} * \text{Resolution}[\text{pulses}/\text{rev}]$$

Linear axis, rotary sensor. The frequency obtained is:

$$f[\text{Hz}] = \frac{\text{speed}[\text{m}/\text{min}] * 1000}{60 * \text{pitch}[\text{mm}/\text{rev}]} * \text{Resolution}[\text{pulses}/\text{rev}]$$

Linear axis, linear sensor. The frequency obtained is:

$$f[\text{Hz}] = \frac{\text{speed}[\text{mm}/\text{s}] * 1000}{\text{Resolution}[\mu\text{m}/\text{pulse}]}$$

Hysteresis. To be changed only if: f_M =green; f_m =red

KEY:

f = frequency

Rpm = rotational speed

Resolution = measurement

Speed = linear speed

Pitch = sensor pitch

TEXT BLOCKS

COMMENTS

This allows a description to be entered and placed in any point of the diagram.

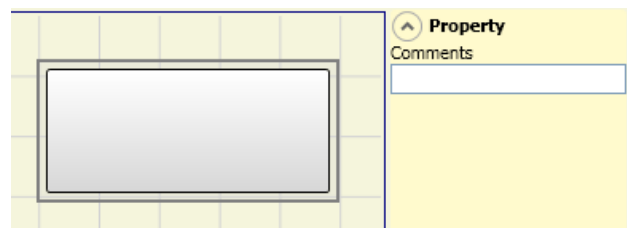

TITLE

Automatically adds the name of the manufacturer, the designer, the project name and the CRC.

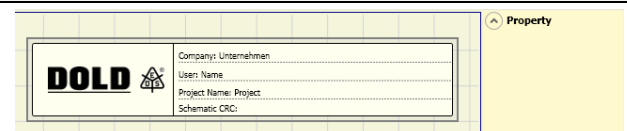

OPERATOR FUNCTION BLOCKS

All the input of these operators could be inverted (logical NOT). It could be done clicking with the right mouse key on the input to be inverted. A little circle will be showed on the inverted input. To cancel the inversion, simply click another time on the same input pin.

➔ The maximum number of user blocks is 64.

LOGICAL OPERATORS

AND

Logical AND returns an output of 1 (TRUE) if all the inputs are 1 (TRUE).

In ₁	In ₂	In _x	Out
0	0	0	0
1	0	0	0
0	1	0	0
1	1	0	0
0	0	1	0
1	0	1	0
0	1	1	0
1	1	1	1

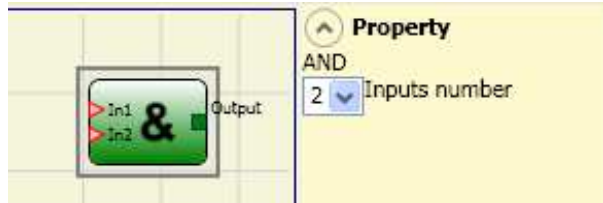

Parameters

Number of inputs: this is used to set between 2 and 8 inputs.

NAND

Logical NAND returns an output of 0 (FALSE) if all the inputs are 1 (TRUE).

In ₁	In ₂	In _x	Out
0	0	0	1
1	0	0	1
0	1	0	1
1	1	0	1
0	0	1	1
1	0	1	1
0	1	1	1
1	1	1	0

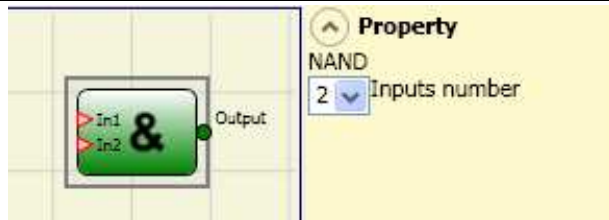

Parameters

Number of inputs: this is used to set between 2 and 8 inputs.

NOT

Logical NOT inverts the logical status of the input.

In	Out
0	1
1	0

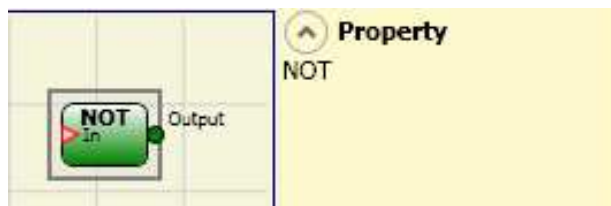

OR

Logical OR returns an output of 1 (TRUE) if at least one of the inputs is 1 (TRUE).

In ₁	In ₂	In _x	Out
0	0	0	0
1	0	0	1
0	1	0	1
1	1	0	1
0	0	1	1
1	0	1	1
0	1	1	1
1	1	1	1

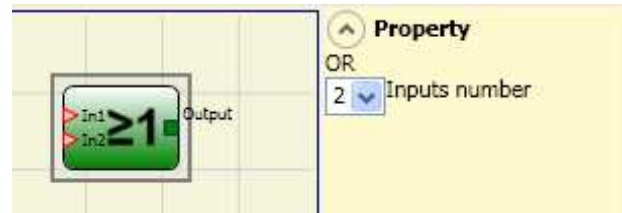
**Parameters**

Number of inputs: this is used to set between 2 and 8 inputs.

NOR

Logical NOR returns an output of 0 (FALSE) if at least one of the inputs is 1 (TRUE).

In ₁	In ₂	In _x	Out
0	0	0	1
1	0	0	0
0	1	0	0
1	1	0	0
0	0	1	0
1	0	1	0
0	1	1	0
1	1	1	0

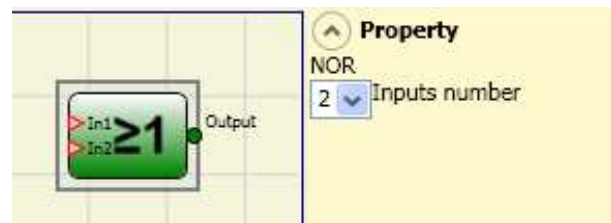
**Parameters**

Number of inputs: this is used to set between 2 and 8 inputs.

XOR

Logical XOR returns an output 0 (FALSE) if the input's number at 1 (TRUE) is even or the inputs are all 0 (FALSE).

In ₁	In ₂	In _x	Out
0	0	0	0
1	0	0	1
0	1	0	1
1	1	0	0
0	0	1	1
1	0	1	0
0	1	1	0
1	1	1	1

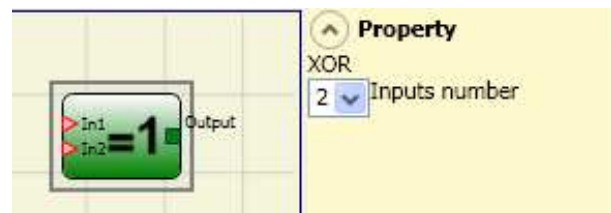
**Parameters**

Number of inputs: this is used to set between 2 and 8 inputs.

XNOR

Logical XNOR returns an output 1 (TRUE) if the input's number at 1 (TRUE) is even or the inputs are all 0 (FALSE).

In1	In2	Inx	Out
0	0	0	1
1	0	0	0
0	1	0	0
1	1	0	1
0	0	1	0
1	0	1	1
0	1	1	1
1	1	1	0

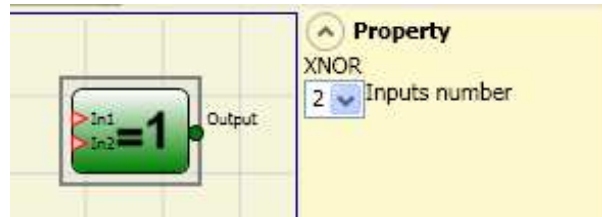

Parameters

Number of inputs: this is used to set between 2 and 8 inputs.

LOGICAL MACRO

This operator enables the grouping together of two or three logic gates.

A maximum of 8 inputs is foreseen.

The result of the first two operators converges into a third operator, the result of which is the OUTPUT.

If one of the Logic Inputs equals "1", the corresponding logic is disabled and the input is directly connected to the end logic (refer to diagram opposite for example).

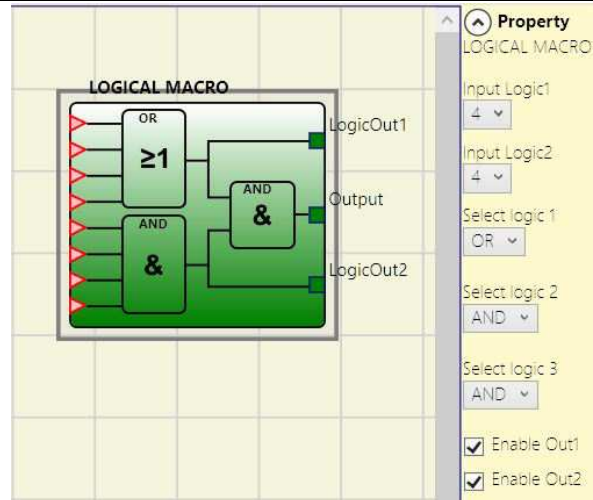

(UG6911 firmware version 3.0 or higher)

Parameters

Logic inputs 1, 2: enables the selection of the number of logic inputs (from 1 to 7).

Select Logic 1, 2, 3: enables the selection of one of the following types of operator: AND, NAND, OR, NOR, XOR, XNOR.

Enable (OUT1, OUT2) If selected, activates an output with the result of the first two operators.

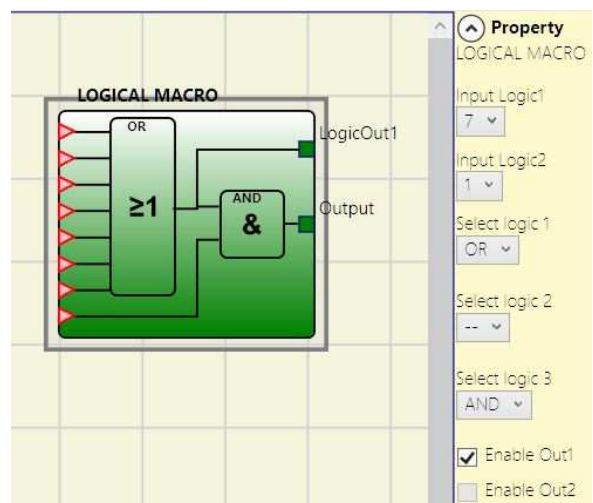

Enable (OUT1, OUT2) If selected, activates an output with the result of the first two operators.

MULTIPLEXER

Logical MULTIPLEXER forwards the signal of the inputs to the output according to the Sel selection. If the SEL1÷SEL4 have only one bit set, the selected *In n* is connected to the Output. If the SEL inputs are:

- more than one = 1 (TRUE)
- none = 1 (TRUE)

The output is set to 0 (FALSE) independently from the *In n* values.

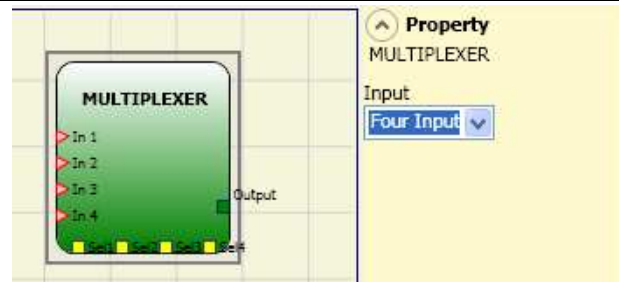

Parameters

Number of inputs: this is used to set between 2 and 4 inputs.

MEMORY OPERATORS

MEMORY operators can be used if you decide to save any data (TRUE or FALSE) from other project components.

Status changes are performed according to the truth tables shown for each operator.

D FLIP FLOP (max number = 16)

The D FLIP FLOP operator saves the previously set status on output Q according to the following truth table.

Preset	Clear	Ck	D	Q
1	0	X	X	1
0	1	X	X	0
1	1	X	X	0
0	0	L	X	Keep memory
0	0	Rising edge	1	1
0	0	Rising edge	0	0

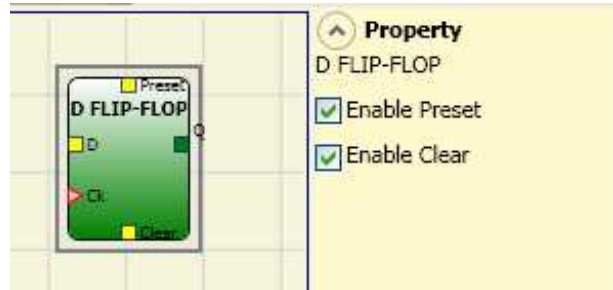

Parameters

Preset. If selected enables output Q to be set to 1 (TRUE).

Clear. If selected enables the saving process to be reset.

SR FLIP FLOP

The SR FLIP FLOP operator saves the previously set status on output Q using Set and Reset according to the following truth table.

SET	RESET	Q
0	0	Keep memory
0	1	0
1	0	1
1	1	0

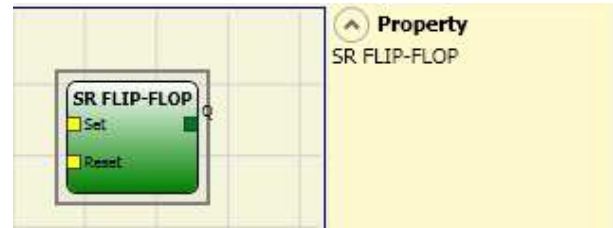

T FLIP FLOP

This operator switches the Q output at each rising edge of the T input (Toggle).

Parameters

Clear. If selected enables the saving process to be reset.

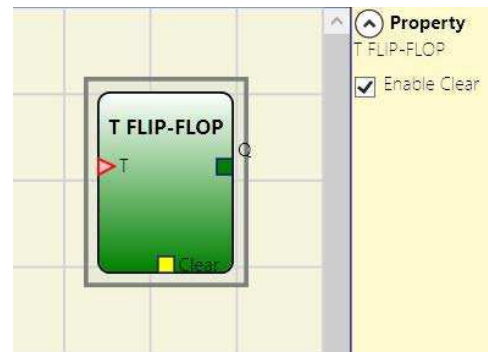

(UG6911 firmware version 3.0 or higher)

USER RESTART MANUAL (max number = 16 USER RESTART at all)

The USER RESTART MANUAL operator saves the restart signal according to the following truth table.

Clear	Restart	In	Q
1	X	X	0
X	X	0	0
0	L	1	Keep memory
0	Rising edge	1	1
0	Falling edge	1	Keep memory



Parameters

Clear enable: If selected enables the saving process to be reset.

USER RESTART MONITORED (max number = 16 USER RESTART at all)

The USER RESTART MONITORED operator is used to save the restart signal according to the following truth table.

Clear	Restart	In	Q
1	X	X	0
X	X	0	0
0	L	1	Keep memory
0	Rising edge	1	Keep memory
0		1	1



Parameters

Clear enable: If selected enables the saving process to be reset.

MACRO RESTART MANUAL (max number = 16 USER RESTART at all)

The MACRO RESTART MANUAL operator is used to combine a logic gate chosen by the user with the Restart Manual functional block ("USER RESTART MANUAL") in accordance with the following truth table.

Clear	Restart	In	Q
1	X	X	0
X	X	0	0
0	L	1	Keep memory
0	Rising edge	1	1
0	Falling edge	1	Keep memory

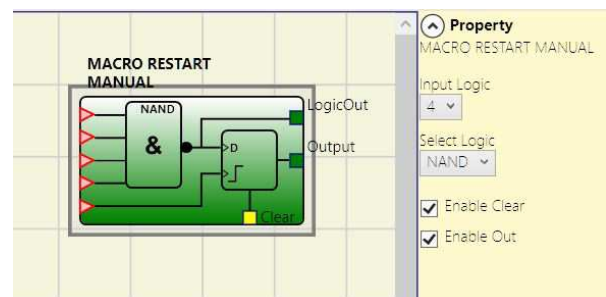

(UG6911 firmware version 3.0 or higher)

Parameters

Logic Inputs: enables the selection of the number of logic inputs (from 1 to 7).

Select Logic: enables the selection of one of the following types of operator: AND, NAND, OR, NOR, XOR, XNOR.

Enable Clear: If selected enables the saving process to be reset.

Enable Out: If selected activates an output with the result of the calculation done by the logic.

MACRO RESTART MONITORED (max number = 16 USER RESTART at all)

The MACRO RESTART MONITORED operator is used to combine a logic gate chosen by the user with the Restart Manual functional block ("USER RESTART MONITORED") in accordance with the following truth table.

Clear	Restart	In	Q
1	X	X	0
X	X	0	0
0	L	1	Keep memory
0	Rising edge	1	Keep memory
0		1	1

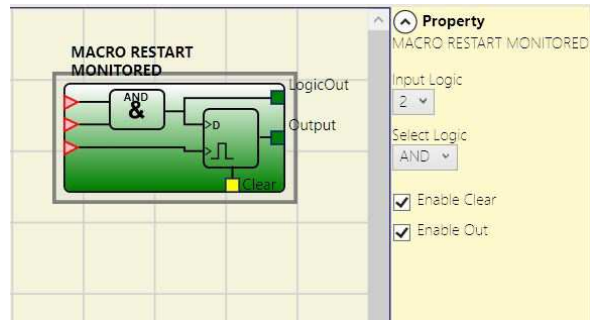

(UG6911 firmware version 3.0 or higher)

Parameters

Logic Inputs: enables the selection of the number of logic inputs (from 1 to 7).

Select Logic: enables the selection of one of the following types of operator: AND, NAND, OR, NOR, XOR, XNOR.

Enable Clear: If selected enables the saving process to be reset.

Enable Out: If selected activates an output with the result of the calculation done by the logic.

GUARD LOCK OPERATORS

GUARD LOCK

The GUARD LOCK operator controls locking/unlocking of an **ELECTROMECHANICAL GUARD LOCK** by analysing consistency between the Lock command and the status of an E-GATE and a FEEDBACK. The main output is 1 (TRUE) when the guard lock is closed and locked.

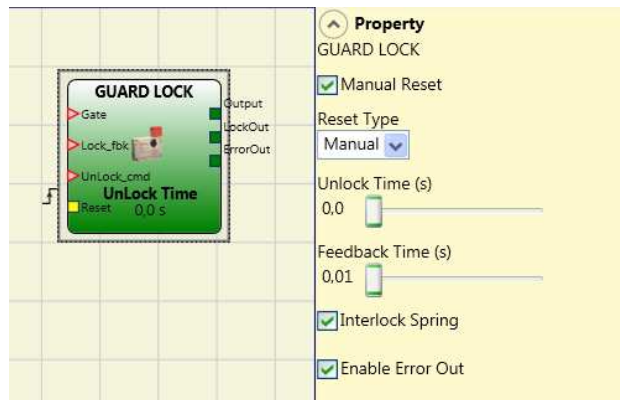

Operating principles.

1. The **GATE** input must always be connected to an **E_GATE** lock input (guard feedback).
2. The **Lock_fbk** input must always be connected to a **LOCK FEEDBACK** (feedback coil lock) input element.

3. The **UnLock_cmd** input can be connected freely in the diagram and determines the request to unlock (when in LL1 state).
4. The **OUTPUT** signal of this element is 1 (TRUE) if the guard is closed and locked. When an unlock command is applied to the **UnLock_cmd** input, the **OUTPUT** signal is set to "0" and the guard is unlocked (**LockOut** output) after a **UnLock Time** configurable as parameter. This output goes to 0 (FALSE) even when error conditions are present (eg. open door with lock locked, **Feedback Time** that exceeds the maximum allowed, ...).
5. **LockOut** signal controls the locking/unlocking of the guard.

Parameters

UnLock Time (s): The time that must pass between the **UnLock_cmd** input reaching and the real guard unlock (**LockOut output**).

- 0 ms ÷ 1 s Step 100 ms
- 1.5 s ÷ 10 s Step 0.5 s
- 15 s ÷ 25 s Step 5 s

Feedback Time (s): Maximum delay accepted between **LockOut** output and **Lock_fbk** input (must be the one shown on the lock data sheet with appropriate gap decided by the operator).

- 10 ms ÷ 100 s Step 10
- 150 ms ÷ 1 s Step 50 ms
- 1.5 s ÷ 3 s Step 0.5 s

Interlock Spring: The guard is locked passively and released actively, i.e. the mechanical force of the spring keeps it locked. The guard thus continues to be locked even when the power supply is disconnected.

Manual Reset:

There are two types of reset: Manual and Monitored. When Manual is selected the system only verifies the signal's transition from 0 to 1. If Monitored is selected the double transition from 0 to 1 and then back to 0 is verified

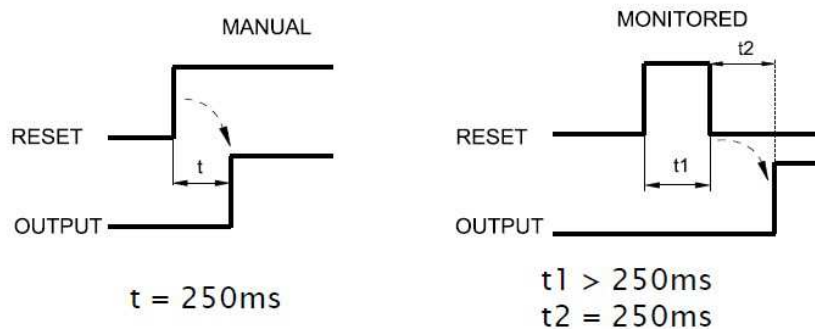

Enable error out: This can be selected to enable a signal (Error Out) to indicate a lock malfunction. When Error Out = 1 (TRUE) there is a fault in the lock.

COUNTER OPERATORS

COUNTER operators can be used to generate a signal (TRUE) as soon as the set count is reached.

COUNTER (max number = 16)

The operator COUNTER is a pulse counter. There are 3 operating modes:

- 1) AUTOMATIC
- 2) MANUAL
- 3) AUTOMATIC + MANUAL

- 1) The counter generates a pulse duration equal to the system response time as soon as the set count is reached. If the CLEAR pin is not enabled this is the default mode.
- 2) The counter leads to 1 (TRUE) the output Q as soon as it reaches the set count. The output Q goes to 0 (FALSE) when the signal CLEAR is activated.
- 3) The counter generates a pulse duration equal to the system response time as soon as the set count is reached. If the CLEAR signal is activated, the internal count goes back to 0.

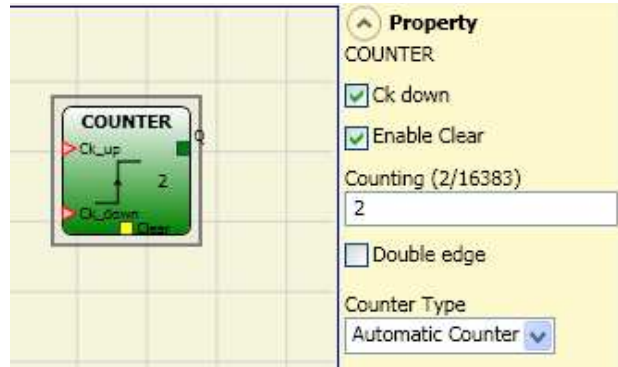

Parameters

Clear Enable: If selected this enables the request to clear in order to restart the counter setting output Q to 0 (FALSE). It also offers the possibility of enabling or not enabling (*Automatic Enable*) automatic operation with manual reset.

If this is not selected operation is automatic. Once the set count is reached output Q is set to 1(TRUE) and stays in this condition for two internal cycles after which it is reset.

Ck down: Enables counting down.

Two-way: If selected it enables counting on both the rising and falling edges.

TIMER OPERATORS (max number = 16)

TIMER operators allow you to generate a signal (TRUE or FALSE) for a user-definable period.

➔ At all, maximum 16 timer operators can be used in the system

CLOCKING

The CLOCKING operator generates a clock signal output with the set period if the input is 1 (TRUE).

Parameters

Time: The period can be set to between **10ms** and **1093.3s**.

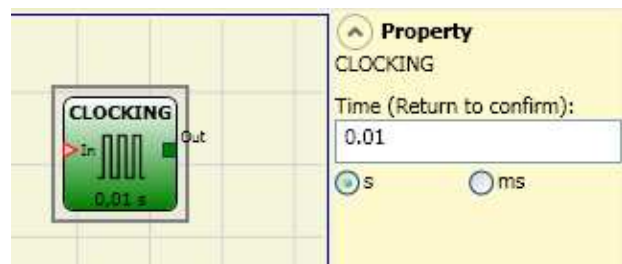

➔ At all, maximum 16 timer operators can be used in the system

MONOSTABLE

The MONOSTABLE operator generates a level 1 (TRUE) output activated by the rising edge of the input and remains in this condition for the set time.

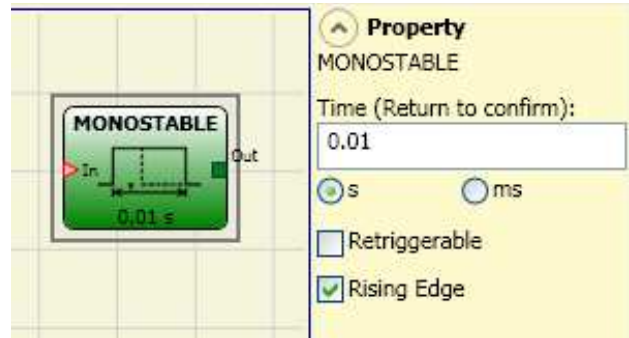

Parameters

Time: The delay can be set to between 10ms and 1093.3s.

Rising edge: If selected, the output is set to 1 (TRUE) on the input signal's rising edge where it remains for the set time, which can be extended for as long as the input stays at 1 (TRUE).

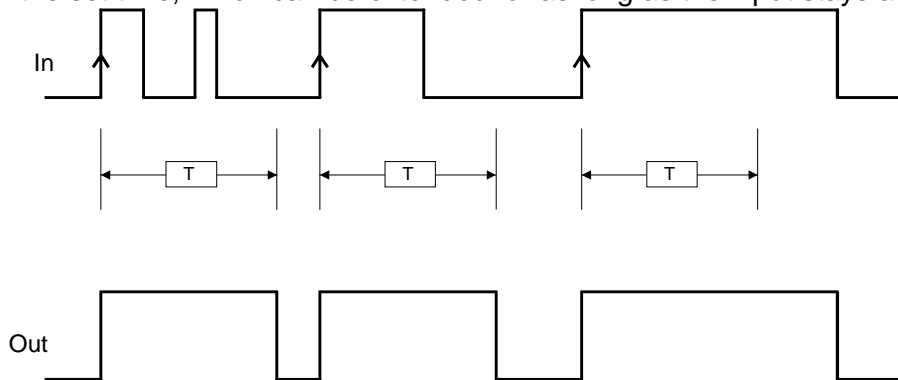

If not selected the logic is inverted, the output is set to 0 (FALSE) on the input signal's falling edge, where it remains for the set time, which can be extended for as long as the input stays at 0 (FALSE).

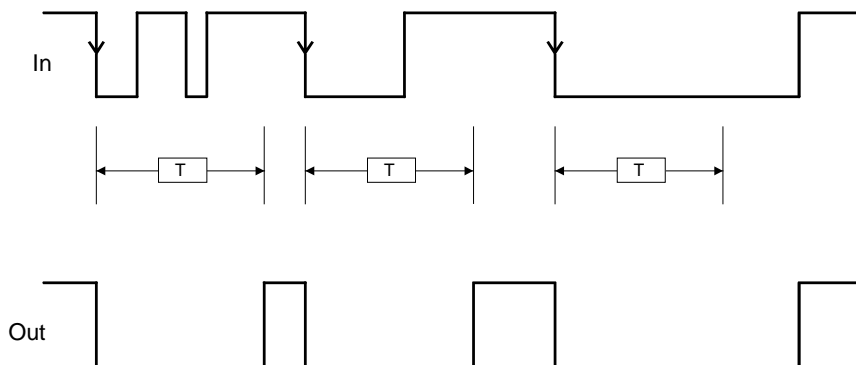

Retriggerable: If selected the time is reset each time the input status changes.

➔ At all, maximum 16 timer operators can be used in the system

MONOSTABLE_B

The MONOSTABLE_B operator generates a level 1 (TRUE) output activated by the rising edge of the input and remains in this condition for the set time.

Parameters

Time: The delay can be set to between 10ms and 1093.3s.

Retriggerable: If selected the time is reset each time the input status changes.

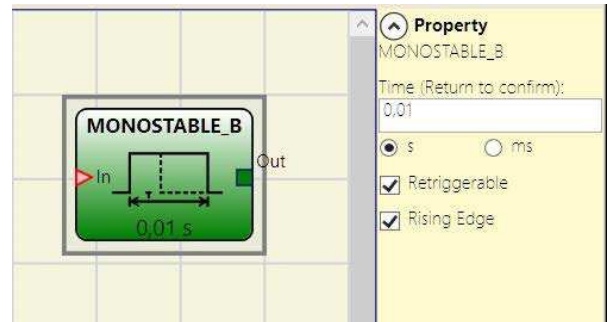

(UG6911 firmware version 3.0 or higher)

Rising edge: If selected, the output is set to 1 (TRUE) on the input signal's rising edge.

Unlike the MONOSTABLE operator, the output of MONOSTABLE_B does not maintain a level 1 (TRUE) for a time which exceeds the set period t .

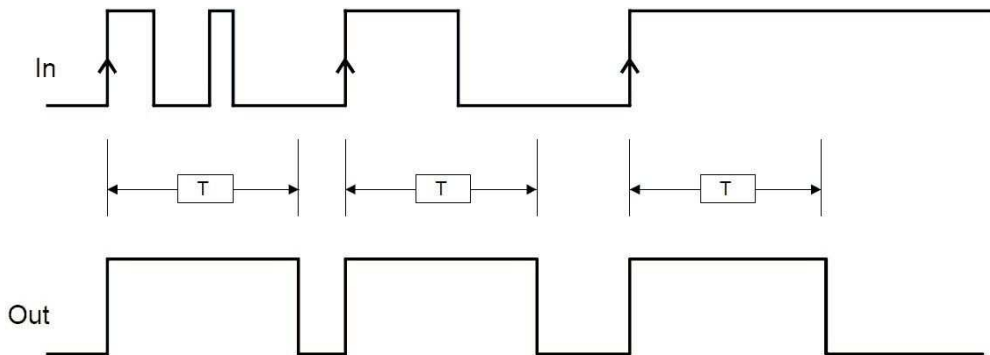

If not selected, the logic is inverted, i.e. the output is set to 0 (FALSE) on the input signal's falling edge.

Unlike the MONOSTABLE operator, the output of MONOSTABLE_B does not maintain a level 0 (FALSE) for a time which exceeds the set period t .

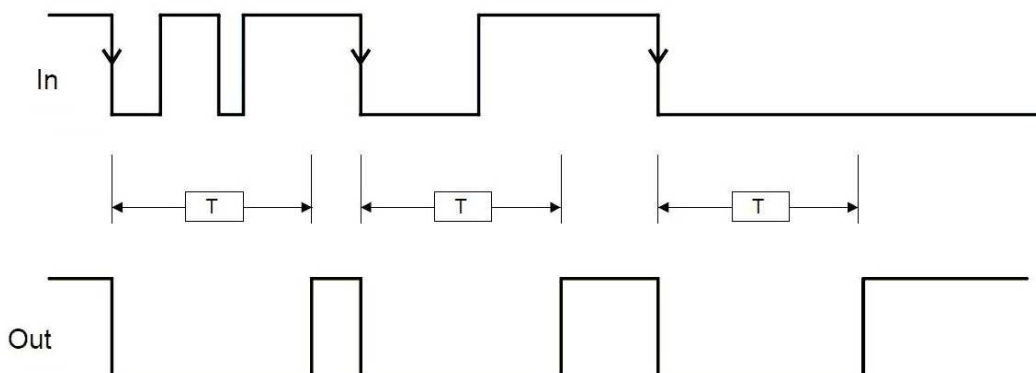

Retriggerable: If selected the time is reset each time the input status changes.

➔ At all, maximum 16 timer operators can be used in the system

PASSING MAKE CONTACT

In the PASSING MAKE CONTACT operator the output follows the signal on the input. However, if this is 1 (TRUE) for longer than the set time, the output changes to 0 (FALSE).
When there is an input falling edge, the timer is cleared.

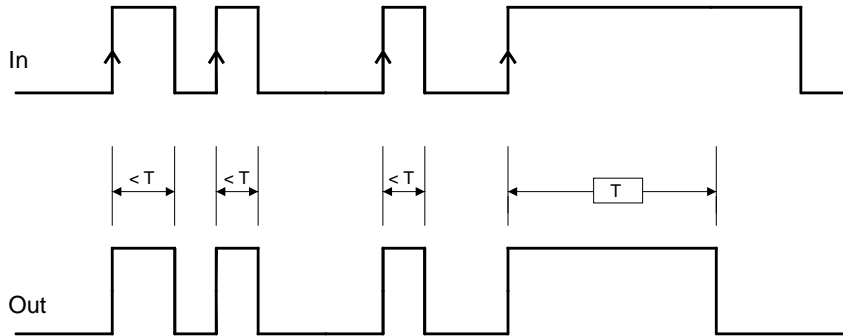
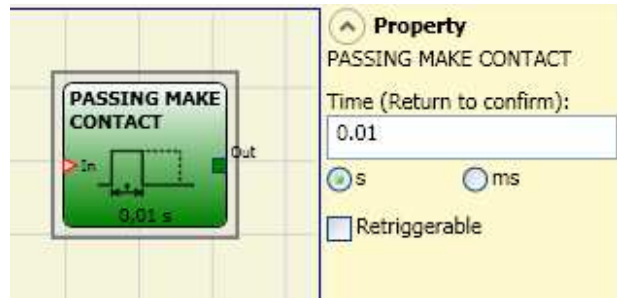

Parameters

Time: The delay can be set to between **10ms and 1093.3s**.

Retriggerable: If selected the time is not reset when there is an input falling edge. The output stays 1 (TRUE) for all the selected time. When there is a new input rising edge, the timer restarts again.

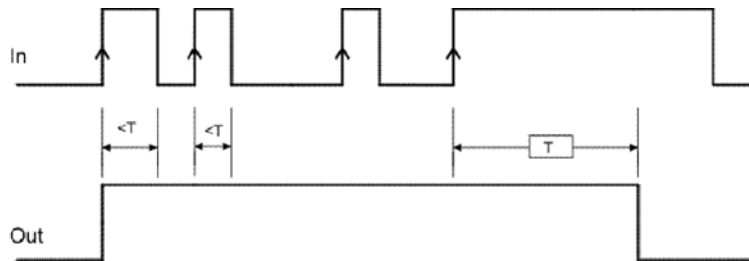

➔ At all, maximum 16 timer operators can be used in the system

DELAY

The DELAY operator applies a delay to a signal by setting the output to 1 (TRUE) after the set time, against a change in the level of the input signal.

Parameters

Time: The delay can be set to between **10ms and 1093.3 s**.

Rising edge: If selected, the delay starts on the input signal's rising edge at the end of which the output changes to 1 (TRUE) if the input is 1 (TRUE) where it remains for as long as the input stays at 1 (TRUE).

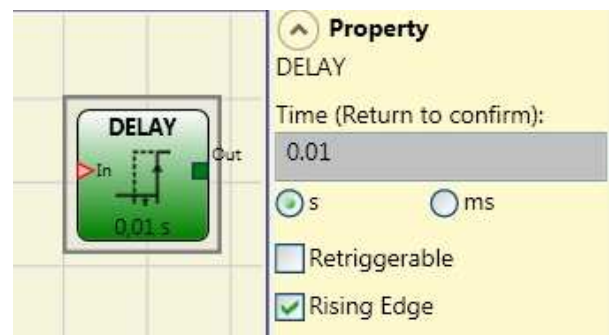

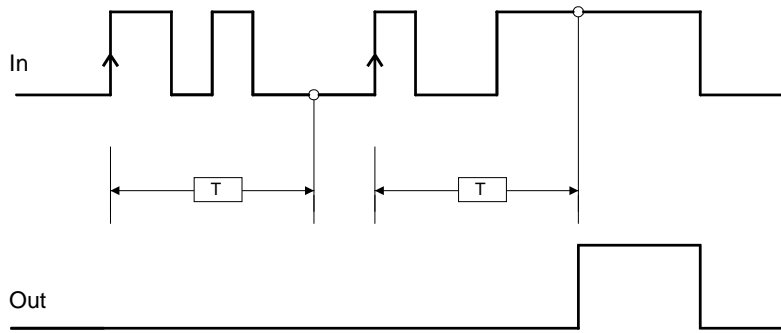

If not selected the logic is inverted, the output is set to 1 (TRUE) on the input signal's rising edge, the delay starts on the input signal's falling edge, at the end of the set time the output changes to 0 (FALSE) if the input is 0 (FALSE) otherwise it remains 1 TRUE.

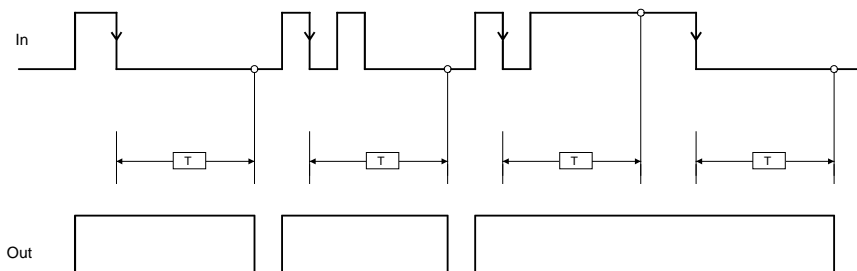

Retriggerable: If selected the time is reset each time the input status changes.

➔ At all, maximum 16 timer operators can be used in the system

DELAY LINE

This operator applies a delay to a signal by setting the OUT output to 0 after the set time, set at a falling edge of the In signal.
 If In returns to 1 before the end of the set time, the OUT output still generates an LLO impulse lasting approximately twice the response time and delayed by the set time.

Parameters

Time: Enables the insertion of the desired delay time by selecting the preferred unit of measurement. The delay can be set to between 10 ms and 1098.3 s

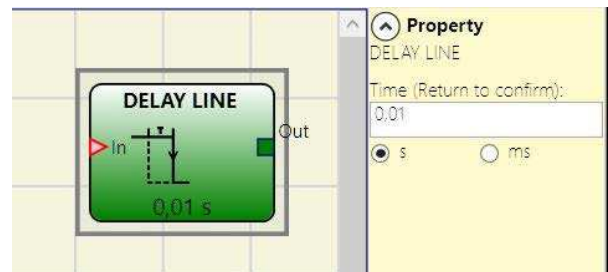

(UG6911 firmware version 3.0 or higher)

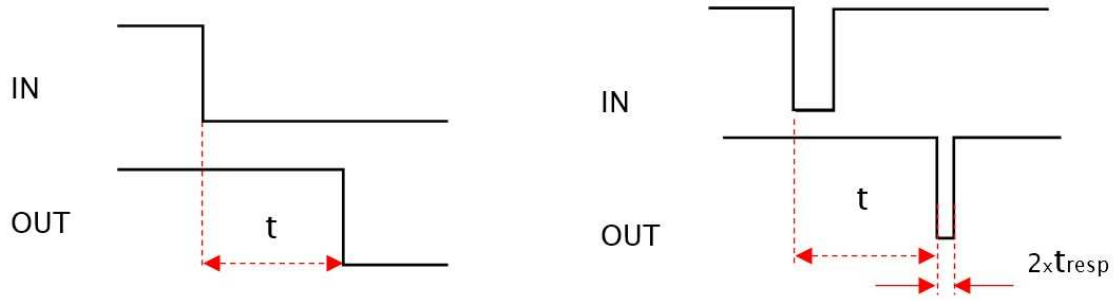

Unlike the DELAY operator, the DELAY LINE operator does not filter any interruptions in the IN input which are shorter than the set time.

This operator is recommended when using delayed OSSD (the OSSD must be programmed with RESTART MANUAL).

➔ At all, maximum 16 timer operators can be used in the system

MUTING OPERATORS (max number = 4)

➔ At all, maximum 4 muting operators and maximum 4 muting override operators can be used in the system

"Concurrent" MUTING

The MUTING operator with "Concurrent" logic performs muting of the input signal through sensor inputs S1, S2, S3 and S4.

➔ Preliminary condition: The Muting cycle can only start if all the sensors are 0 (FALSE) and inputs are 1 (TRUE) (barrier free).

Parameters

Timeout (sec): Sets the time, between 10 secs and unlimited, within which the Muting cycle must end. If the cycle is not complete at the end of this time, Muting is immediately discontinued.

Enable: If selected it enables the possibility of enabling or not enabling the Muting function. Otherwise the Muting function is always enabled.

There are two Enable modes: *Enable/Disable* and *Enable Only*. If *Enable/Disable* is selected the Muting cycle cannot start if Enable is fixed at 1 (TRUE) or 0 (FALSE) but is only activated with a rising edge. To disable muting, set Enable to 0 (FALSE). In this mode the falling edge disables Muting regardless of the condition. If *Enable Only* is selected Muting cannot be disabled but Enable must be set to 0 (FALSE) in order to enable a new rising edge for the next Muting cycle.

Direction: The order in which the sensors are occupied can be set. If set to BIDIR they can be occupied in both directions, from S1&S2 to S3&S4 and from S3&S4 to S1&S2, if set to UP they can be occupied from S1&S2 to S3&S4 and if set to DOWN from S3&S4 to S1&S2.

Muting Closing: There are two types, CURTAIN and SENSOR. If you select CURTAIN muting closes when the input signal rises, if you select SENSOR it closes when the third sensor has been cleared.

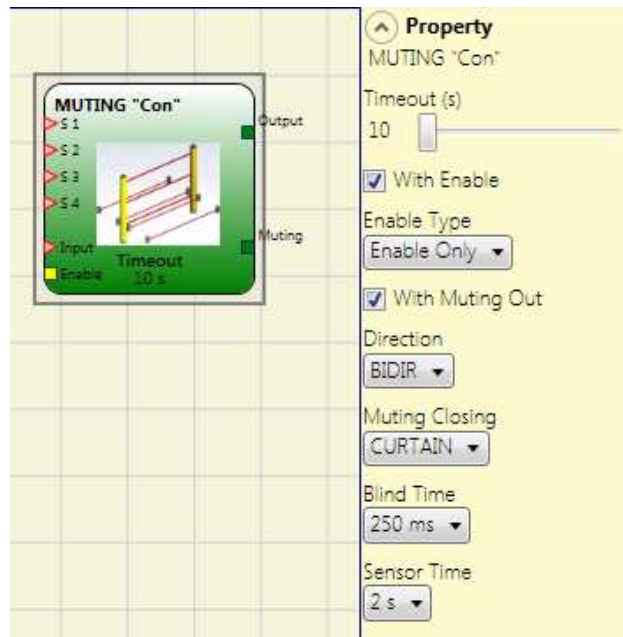

Select CURTAIN

S1	S2	Input	S3	S4	Muting
0	0	1	0	0	0
1	0	1	0	0	0
1	1	1	0	0	1
1	1	X	0	0	1
1	1	X	1	1	1
0	0	0	1	1	1
0	0	1	1	1	0
0	0	1	0	0	0

Select SENSOR

S1	S2	Input	S3	S4	Muting
0	0	1	0	0	0
1	0	1	0	0	0
1	1	1	0	0	1
1	1	X	0	0	1
1	1	X	1	1	1
0	0	0	1	1	1
0	0	1	1	1	1
0	0	1	0	1	0
0	0	1	0	0	0

Blind Time: Only with Muting Close=Curtain, blind time is enabled if you know that after the complete transition of the pallet (muting cycle close) some protruding objects could still occupy the light curtain and send the input to 0 (FALSE). During blind time the input remains 1 (TRUE). Blind Time can range from 250msecs to 1 second.

Sensor time: A difference of between 2 and 5 seconds can be set for activating the sensors.

Minimum sensors time: If selected, allows the activation of Muting cycle only if a time >150ms elaps between the activation of sensor 1 and sensor 2, or sensor 3 and 4 respectively.

➔ At all, maximum 4 muting operators can be used in the system

MUTING “L”

The MUTING operator with “L” logic performs muting of the input signal through sensor inputs S1 and S2.

➔ Preliminary condition: The Muting cycle can only start if S1 and S2 are 0 (FALSE) and the inputs are 1 (TRUE) (barrier free).

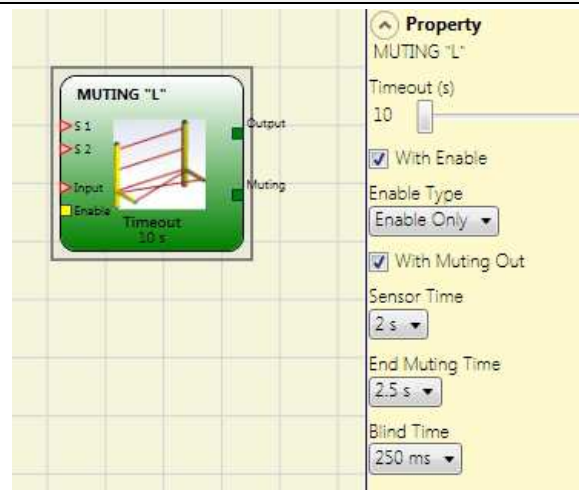

Parameters

Timeout (sec): Sets the time, between 10 secs and unlimited, within which the Muting cycle must end. If the cycle is not complete at the end of this time, Muting is immediately discontinued.

Enable: If selected it enables the possibility of enabling or not enabling the Muting function. Otherwise the Muting function is always enabled. There are two Enable modes: Enable/Disable and Enable Only. If Enable/Disable is selected the Muting cycle cannot start if Enable is fixed at 1 (TRUE) or 0 (FALSE) but is only activated with a rising edge. To disable muting, set Enable to 0 (FALSE). In this mode the falling edge disables Muting regardless of the condition. If Enable Only is selected Muting cannot be disabled but Enable must be set to 0 (FALSE) in order to enable a new rising edge for the next Muting cycle.

Sensor time: A difference of between 2 and 5 seconds can be set for activating the sensors.

End of Muting time: Sets the muting falling time, from 2.5 to 6 seconds, after the second sensor has been cleared.

Blind Time: enabled if you know that after the complete transition of the pallet (muting cycle close) some protruding objects could still occupy the light curtain and send the input to 0 (FALSE). During blind time the input remains 1 (TRUE). Blind Time can range from 250msecs to 1 second.

➔ At all, maximum 4 muting operators can be used in the system

"Sequential" MUTING

The MUTING operator with "Sequential" logic performs muting of the input signal through sensor inputs S1, S2, S3 and S4.

➔ Preliminary condition: The Muting cycle can only start if all the sensors are 0 (FALSE) and the inputs are 1 (TRUE) (barrier free).

Parameters

Timeout (sec): Sets the time, between 10 secs and unlimited, within which the Muting cycle must end. If the cycle is not complete at the end of this time, Muting is immediately discontinued.

Enable: If selected it enables the possibility of enabling or not enabling the Muting function. Otherwise the Muting function is always enabled.

There are two Enable modes: Enable/Disable and Enable Only. If Enable/Disable is selected the Muting cycle cannot start if Enable is fixed at 1 (TRUE) or 0 (FALSE) but is only activated with a rising edge. To disable muting, set Enable to 0 (FALSE). In this mode the falling edge disables Muting regardless of the condition. If Enable Only is selected Muting cannot be disabled but Enable must be set to 0 (FALSE) in order to enable a new rising edge for the next Muting cycle.

Direction: The order in which the sensors are occupied can be set. If set to BIDIR they can be occupied in both directions, from S1 to S4 and from S4 to S1, if set to UP they can be occupied from S1 to S4 and if set to DOWN from S4 to S1.

Muting Closing: There are two types, CURTAIN and SENSOR. If you select CURTAIN muting closes when the input signal rises, if you select SENSOR it closes when the last sensor has been cleared.

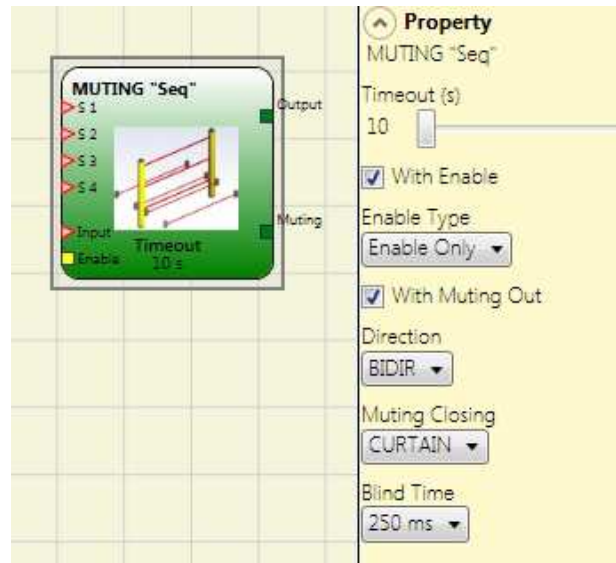

Select CURTAIN

S1	S2	Input	S3	S4	Muting
0	0	1	0	0	0
1	0	1	0	0	0
1	1	1	0	0	1
1	1	X	0	0	1
1	1	X	1	0	1
1	1	X	1	1	1
0	1	X	1	1	1
0	0	0	1	1	1
0	0	1	1	1	0
0	0	1	0	1	0
0	0	1	0	0	0

Select SENSOR

S1	S2	Input	S3	S4	Muting
0	0	1	0	0	0
1	0	1	0	0	0
1	1	1	0	0	1
1	1	X	0	0	1
1	1	X	1	0	1
1	1	X	1	1	1
0	1	X	1	1	1
0	0	0	1	1	1
0	0	1	1	1	1
0	0	1	0	1	0
0	0	1	0	0	0

Blind Time: Only with Muting Close=Curtain, blind time is enabled if you know that after the complete transition of the pallet (muting cycle close) some protruding objects could still occupy the light curtain and send the input to 0 (FALSE). During blind time the input remains 1 (TRUE). Blind Time can range from 250msecs to 1 second.

➔ At all, maximum 4 muting operators can be used in the system

MUTING “T”

The MUTING operator with “T” logic performs muting of the input signal through sensor inputs S1 and S2.

➔ Preliminary condition: The Muting cycle can only start if S1 and S2 are 0 (FALSE) and the inputs are 1 (TRUE) (barrier free).

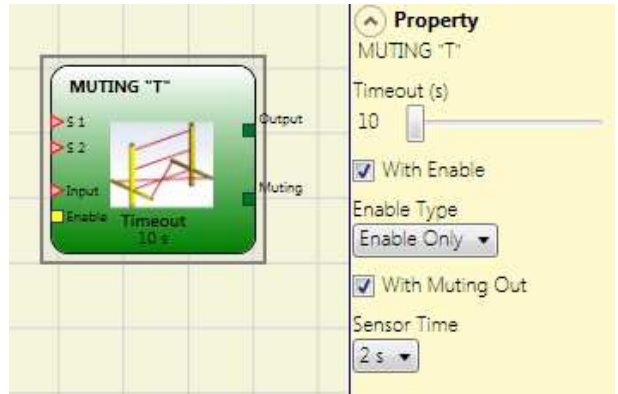

Parameters

Timeout (sec): Sets the time, between 10 secs and unlimited, within which the Muting cycle must end. If the cycle is not complete at the end of this time, Muting is immediately discontinued.

Enable: If selected it enables the possibility of enabling or not enabling the Muting function. Otherwise the Muting function is always enabled.

There are two Enable modes: Enable/Disable and Enable Only. If Enable/Disable is selected the Muting cycle cannot start if Enable is fixed at 1 (TRUE) or 0 (FALSE) but is only activated with a rising edge. To disable muting, set Enable to 0 (FALSE). In this mode the falling edge disables Muting regardless of the condition. If Enable Only is selected Muting cannot be disabled but Enable must be set to 0 (FALSE) in order to enable a new rising edge for the next Muting cycle.

Sensor time: A difference of between 2 and 5 seconds can be set for activating the sensors.

➔ At all, maximum 4 muting operators can be used in the system

MUTING OVERRIDE (max number = 4)

The operator permits override of the directly connected Muting Input.

Override can be activated only if Muting is not active (INPUT=0) and at least one Muting sensor is occupied (or the light curtain is occupied).

Override ends when the light curtain and sensors are cleared and the Output switches to logical "0" (FALSE).

Override can be set to pulsed or maintained action mode.

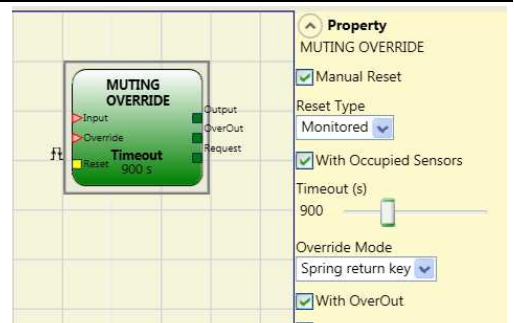

Override with maintained action control

This function must be activated maintaining the Override command active (OVERRIDE=1) during all subsequent operations. However, a new Override can be activated, de-activating and re-activating the command.

When the light curtain and sensors are cleared (gap free) or on expiry of the timeout, Override ends without the need for further commands.

Override with pulsed action

This function is enabled activating the Override command (OVERRIDE=1).
 Override ends when the light curtain and sensors are cleared (gap free) or on expiry of the timeout.
 The function can be restarted only if the Override command is re-activated (OVERRIDE=1)

Parameters

Manual Reset:

- Should the INPUT be active (TRUE), the reset enables the output of the function block.
- Should the INPUT be not active (FALSE), the output of the function block follows the OVERRIDE request.

There are two types of reset: Manual and Monitored. When Manual is selected the system only verifies the signal's transition from 0 to 1. If Monitored is selected the double transition from 0 to 1 and then back to 0 is verified.

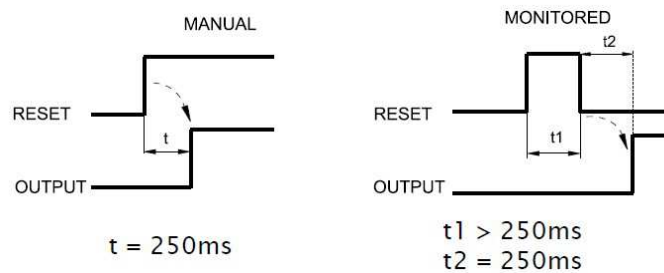

With sensors occupied:

- must be selected with "Concurrent" MUTING, "Sequential" MUTING and "T Muting".
- must not be selected with "L" muting.

➔ Otherwise, a Warning is displayed in the compilation phase and in the report.
 ➔ The user must adopt additional safety measures during the Override phase.

Conditions to be checked for activation of Override

"With sensors occupied" selected	sensor occupied	light curtain occupied	Input	Override request	Override output
X	X	-	0	1	1
-	-	X	0	1	1
	X	-	0	1	1
	X	X	0	1	1

Timeout (sec): Used to set the time, between 10 sec and infinity, by which the Override function must end.

Override mode:

Spring return Key:

This function must be activated maintaining the Override command active (OVERRIDE=1) during all subsequent operations. However, a new Override can be activated, de-activating and re-activating the command.
 When the light curtain and sensors are cleared (gap free) or on expiry of the timeout, Override ends without the need for further commands.

Push Button:

This function is enabled activating the Override command (OVERRIDE=1).
 Override ends when the light curtain and sensors are cleared (gap free) or on expiry of the timeout. The function can be restarted only if the Override command is re-activated (OVERRIDE=1).

With OverOut: Used to activate an Override active output (active when high).

With Request: Used to activate an output (active when high) indicating that the Override function can be activated.

Miscellany (special function Blocks)

Serial output

The Serial Output operator outputs the status of up to 8 inputs, serializing the information.

Operating principles.

This operator outputs the status of all the connected inputs in two different ways:

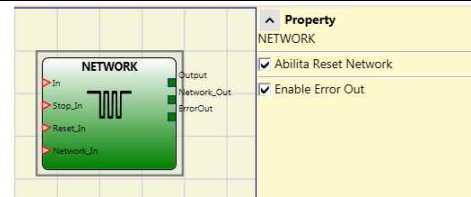

Asynchronous serialization:

- 1) The status of the line in the idle condition is 1 (TRUE);
- 2) The start data transmission signal is 1 bit = (FALSE);
- 3) Transmission of n bits with the status of the connected inputs encoded using the Manchester method:
 - Status 0: rising edge of the signal at the center of the bit
 - Status 1: falling edge of the signal at the center of the bit
- 4) Intercharacter interval is 1 (TRUE) to allow synchronization of an external device.

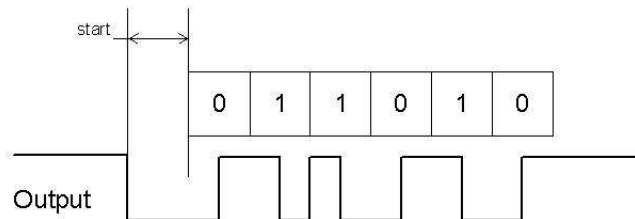

Therefore, with the Asynchronous method the Clock output is not present.

Synchronous serialization:

- 1) The output and the clock in the idle condition are 0 (FALSE);
- 2) Transmission of n bits with the input status using OUTPUT as data, CLOCK as the timing base;
- 3) Intercharacter interval is 0 (FALSE) to allow synchronization of an external device.

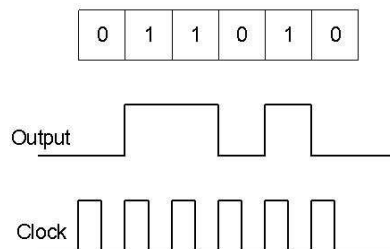

Parameters

Number of inputs: Defines the number of inputs of the function block, which may be 2÷8 (asynchronous) or 3÷8 (synchronous).

Bit length (ms): Enter the value corresponding to the length of each single bit (input n) in the pulse train that makes up the transmission.

- 40ms ÷ 200ms (Step 10ms)
- 250ms ÷ 0.95s (Step 50ms)

Intercharacter interval (ms): Enter the time that must pass between the transmission of one pulse train and the next.

- 100ms ÷ 2.5s (Step 100ms)
- 3s ÷ 6s (Step 500ms)

Network

The Network operator is used to distribute Stop and Reset commands via a simple local network. Use Network_in and Network_out to exchange START, STOP and RUN signals between the different nodes.

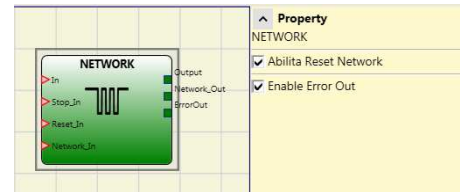

Operating principles:

This operator allows stop and reset commands to be distributed simply in a local PLC network.

The Network operator requires the following:

1. **Network_In** input connected to a single or double input must be connected to the **Network_Out** output of the preceding unit in the local network.
2. **Network_Out** output connected to a STATUS signal or OSSD output must be connected to the **Network_in** input of the next unit in the local network.
3. **Stop_In** and **Reset_In** inputs must be connected to input devices that act as Stop (e.g. E-STOP) and Reset (e.g. SWITCH), respectively.
4. **In** input can be connected freely in the diagram (e.g. input function blocks or results of logical combinations).
5. **Output** can be connected freely in the diagram. **Output** is 1 (TRUE) when the IN input is 1 (TRUE) and the function block has been restarted.

Parameters

Enable Reset Network: when selected this allows the distribution network to reset the function block. If not enabled, the function block can only be reset via the local Reset_In input.

Enable error out: if selected this enables the presence of the Error_Out status signal.

Example of application:

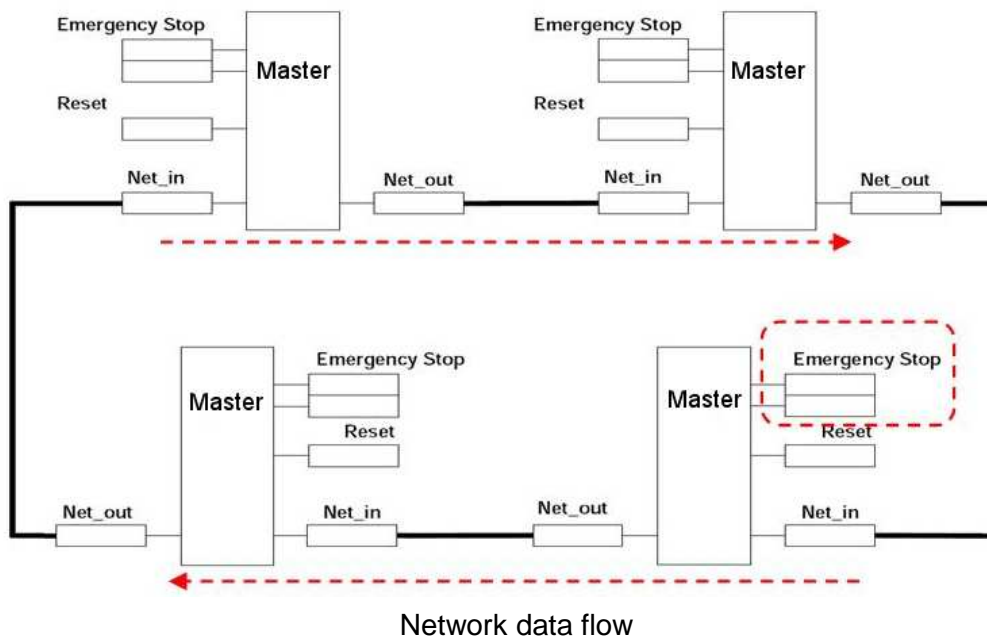

 The RESET commands must be installed outside all the danger areas of the network in positions where the danger areas and the entire work areas are clearly visible.

The maximum number of networkable modules UG6911 is equal to 10.

Condition 1:

With reference to the figure, at power-on:

1. The OUTPUTs of the various nodes are in the 0 (FALSE) condition;
2. The STOP signal is sent via the Network_out line;
3. When the RESET command is pressed on one of the nodes all the nodes that are present are started when the START signal is sent;
4. As the end result, the OUTPUT of all the connected nodes is in condition 1 (TRUE) if the various IN inputs are in condition 1 (TRUE);
5. The RUN signal is sent via the network of the 4 nodes present.

Condition 2:

With reference to the figure, when the emergency stop is pressed in one of the four nodes:

1. The OUTPUT moves to condition 0 (FALSE);
2. The STOP signal is sent via the Network_out line;
3. The next node receives the stop code and deactivates the output;
4. The stop command generates the stop code for all Network_in and Network_out lines;
5. As the end result, the OUTPUT of all the connected nodes is in condition 0 (FALSE).
6. When the emergency stop is restored to the normal position, all the nodes can be restarted by sending the START signal with a single reset. The latter condition does not occur when ENABLE RESET NETWORK is not enabled. In that case, the local reset method must be used.

Response Time

The response time of the network starting from emergency stop is given by the formula:

$$t_{rTot} = (120ms \times n^{o}module) (max 10)$$

example of 4 nodes network:

Emergency Stop Pressure	MASTER	MASTER n°1	MASTER n°2	MASTER n°3
	$t_{rMASTER}$	$120ms \times n^{o}module$	$120ms \times n^{o}module$	$120ms \times n^{o}module$
	12,6ms	120ms	240ms	360ms

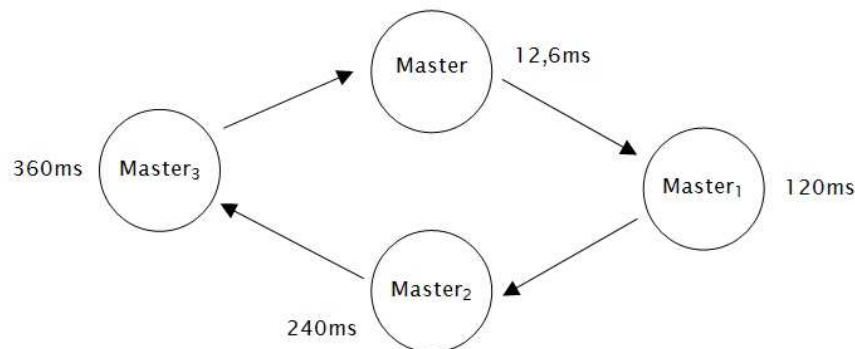

Condition 3:

With reference to the figure, when the IN input of the NETWORK function block of one of the 4 nodes moves to condition 0 (FALSE):

1. The local OUTPUT moves to condition 0 (FALSE);
2. The RUN signal continues to be sent via the Network_out lines;
3. The states of the remaining nodes remain unchanged;
4. In that case, local reset must be used. The Reset-in LED flashes to indicate this condition. All the nodes can be restarted by sending the START signal with a single reset. The latter condition does not occur when ENABLE RESET NETWORK is not enabled. In that case, the local reset method must be used.

LED signals on UG6911.10 with active network

		NETWORK FUNKTIONAL BLOCK SIGNALS				
		Network in		Network out (OSSD)	Network out (STATUS)	Reset in
	LED	FAIL EXT	IN ⁽¹⁾	OSSD ⁽²⁾	STATUS	IN ⁽³⁾
STATUS	STOP	OFF	OFF	red	OFF	OFF
	CLEAR	OFF	blinking	red/green(blinking)	blinking	blinking
	RUN	OFF	ON	green	ON	ON
	FAIL	ON	blinking	-	-	-

(1) LED corresponding to the input where is wired Network IN
 (2) LED corresponding to the output where is wired NETWORK OUT
 (3) LED corresponding to the input where is wired Reset IN

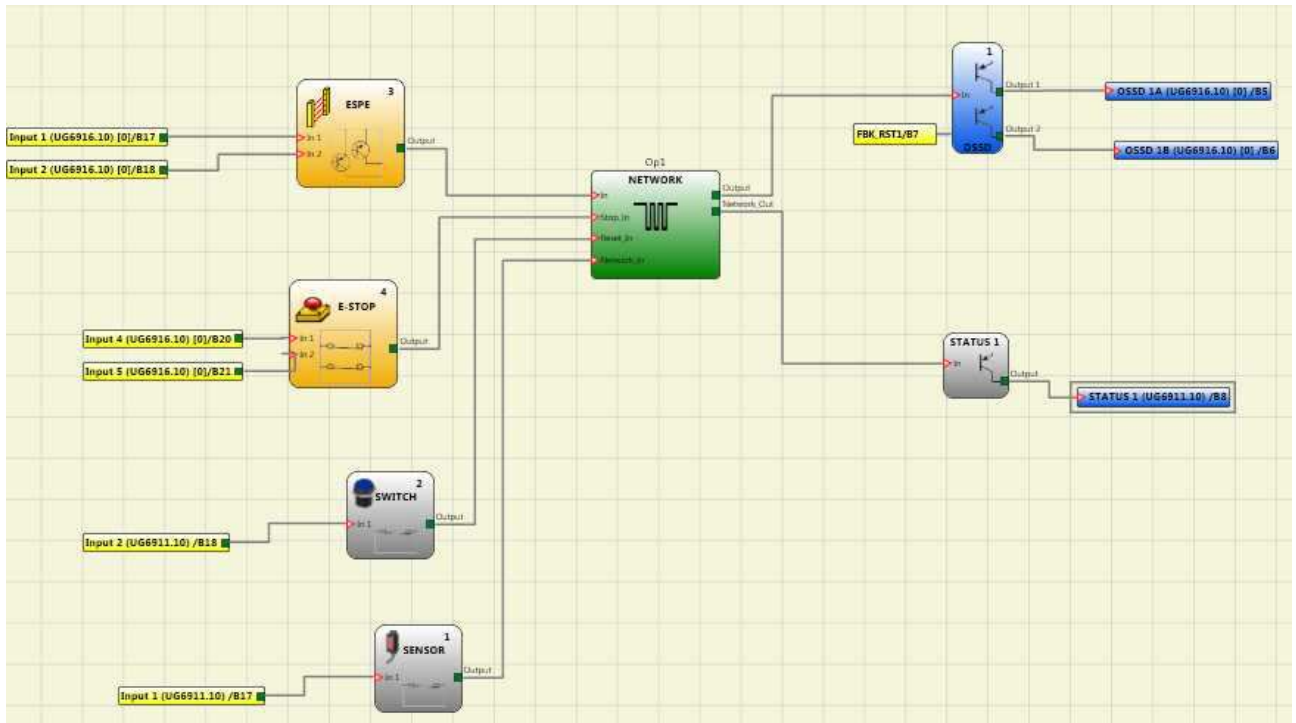

Figure 45 - Example of use of the NETWORK block

➔ The **Reset_in** and **Network_in** inputs and the **Network_out** output can only be mapped to the I/O pins of the Master UG6911.10.

RESET UG6911

This operator generates a system Reset when there is a double OFF-ON-OFF transition on the corresponding input which lasts less than 5 s.

If > 5s, RESET is not generated.

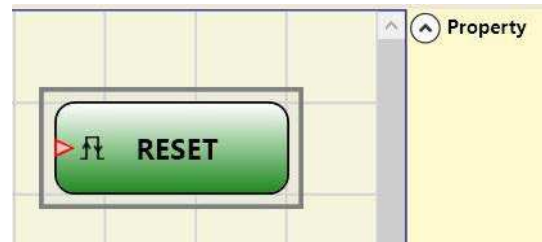

(UG6911 firmware version 3.0 or higher)

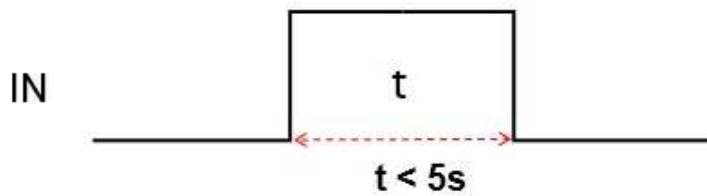

It can be used to reset faults without disconnecting system power.

INTERPAGE IN / OUT

If the scheme is very complicated and requires a connection between two elements very far, use the "Interpage" component.

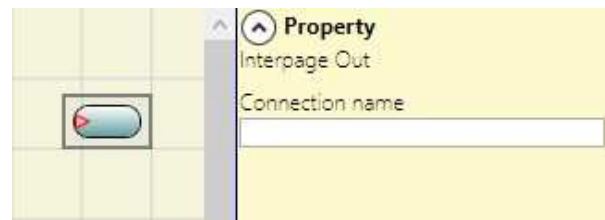

The element "Interpage out" must have a name which, invoked by the corresponding "Interpage in", allows the desired link.

RESET UG6911

This operator can be connected to Input block OUTPUT only to allow this Input to be inserted without schematic connections.

The Input connected to Terminator appears in the Input map list and it's state is transferred to the BUS.



(UG6911 firmware version 3.0 or higher)

SPECIAL APPLICATIONS

Output delay with manual reset

If you need to have two OSSD output with one of them delayed (in MANUAL mode) use the following scheme:

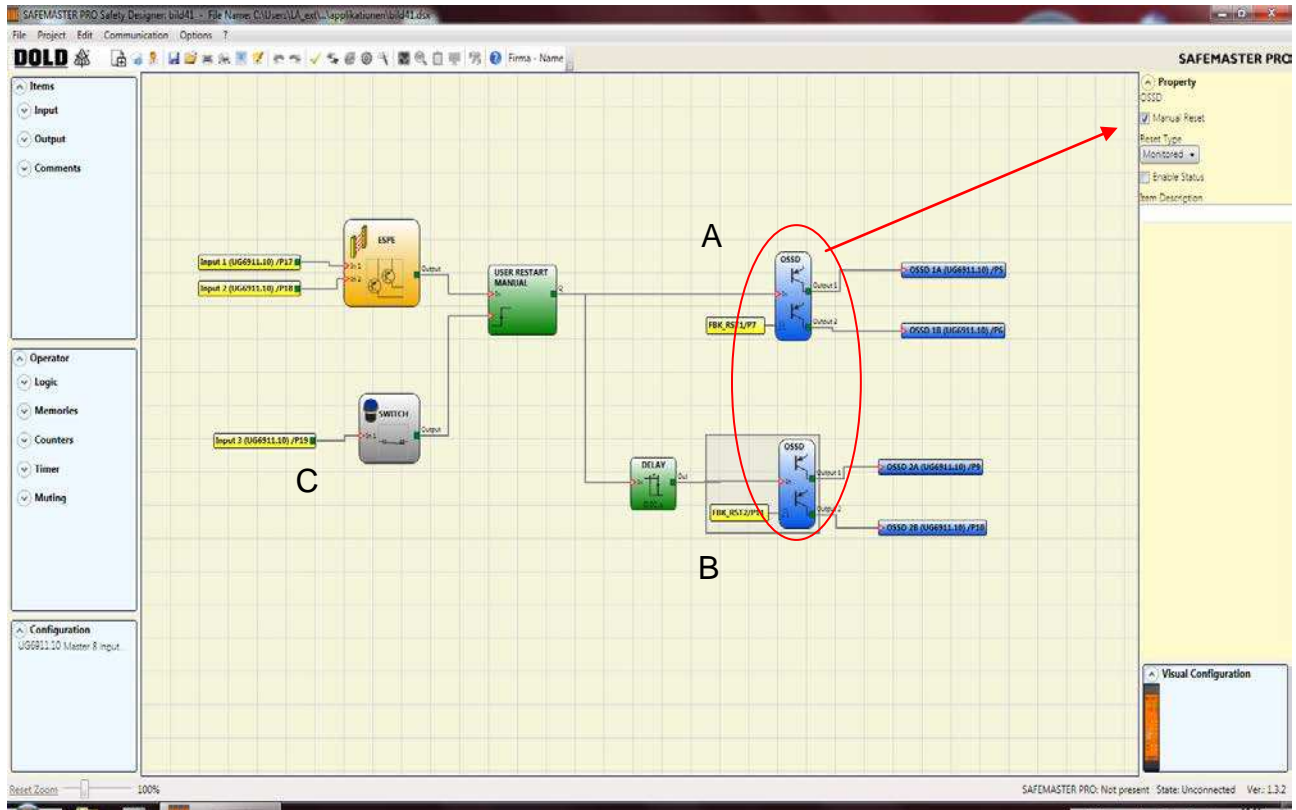

Figure 46 - Two outputs with one delayed (in MANUAL mode)

- ➔ Whereas the operating mode of the logical DELAY (see DELAY paragraph) the application must be the following:
The two outputs have to be programmed with RESET TYPE manual (monitored) using the function USER MANUAL RESTART.
- ➔ You must physically connect the button RESTART on INPUT 3 (C) to the inputs RESTART_FBK1/2 of the OSSD A.

Combination of Two Hand with other safety functions

If a two hand acts of the same output as other safety functions (for example ESPE or E-Stop) the two hands must absolutely be released after a deactivation of the OSSDs due to the other safety functions.

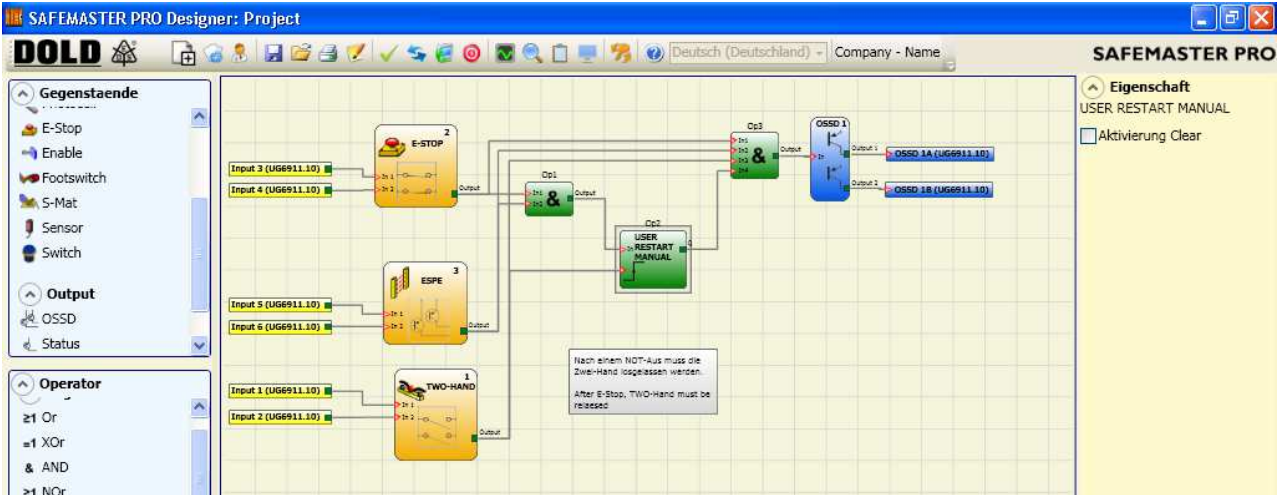

Figure 47 - Example with autostart

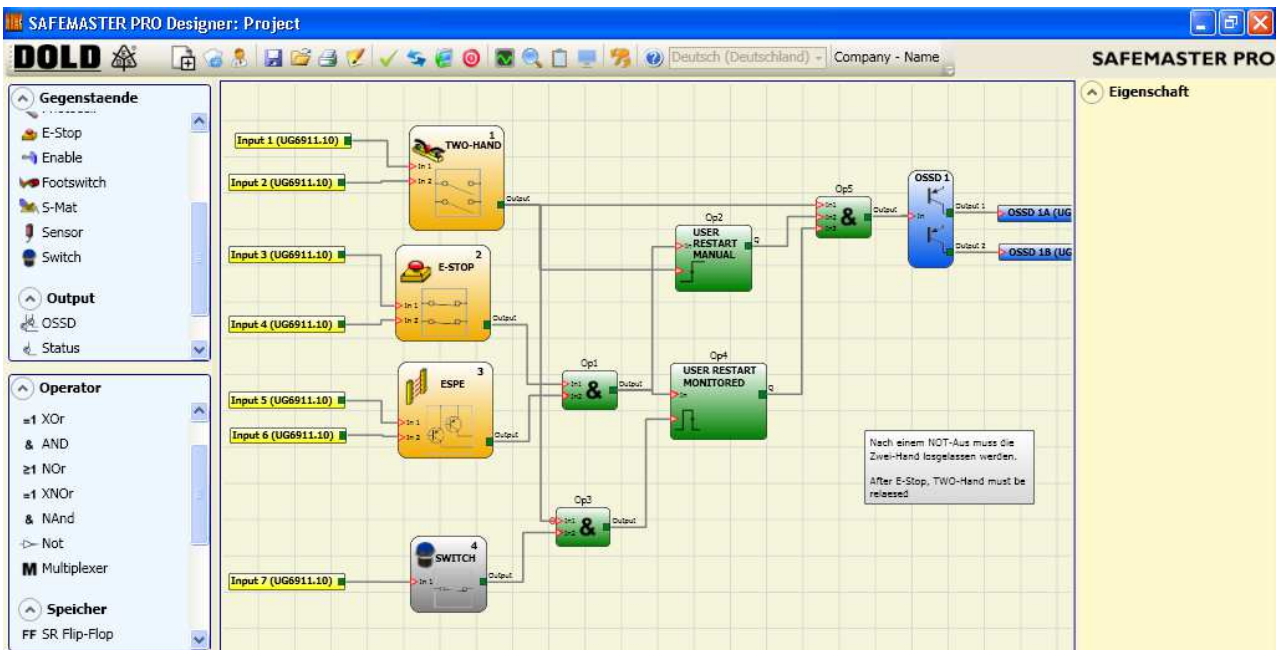







Figure 48 - Example with manual start

SIMULATOR

-  This simulator is only designed to assist in the design of safety functions.
-  The results of the simulation do not constitute validation of the project.
-  The resulting safety function must always be validated, from the point of view of both hardware and software, under actual usage conditions in accordance with the applicable regulations, such as ISO/EN 13849-2: validation or IEC/EN 62061: Chapter 8 - Validation of the safety-related electrical control system.
-  Mosaic configuration safety parameters are provided in the MSD software report.

➔ The simulation is only available with UG6911 firmware version 3.0 or higher.

The top toolbar features two new green icons. These icons refer to the new Simulator functions.

The first icon  indicates "Schematic Simulation". It enables the schematic simulator (both static and dynamic) in which you can activate the input to verify the diagram that is loaded.

The second icon  indicates "Graphic Simulation". It enables the simulator guided by the stimuli file which also allows the desired traces to be displayed in a specific graph.

➔ THE SIMULATION ICONS ARE ONLY AVAILABLE WITH NODE M1 DISCONNECTED.

Schematic Simulation

Click on the icon  to start the schematic simulation.

Schematic simulation can be used to check/guide the output signals of the various function blocks in real-time, even during the actual simulation. You may choose the block outputs you wish to control and check the response of the various elements of the schematic model according to the colour of the different lines.

As with the monitor function, the colour of the line (or of the actual key) indicates the signal status: green means the signal is set to LL1, red means the signal is set to LL0.

With "Schematic Simulation", some new keys appear in the toolbar. These can be used to control the simulation: the "Play" and "Stop" keys to start and stop the simulation, the "PlayStep" key for step-by-step operation and the "Reset" key. When the simulation is reset, the Time value is reset to 0 ms.

When you press "Play" to start the simulation, the amount of time that has elapsed is displayed next to the word "Time". This time is measured in "Step" units of time multiplied by the user-defined "KT" factor.

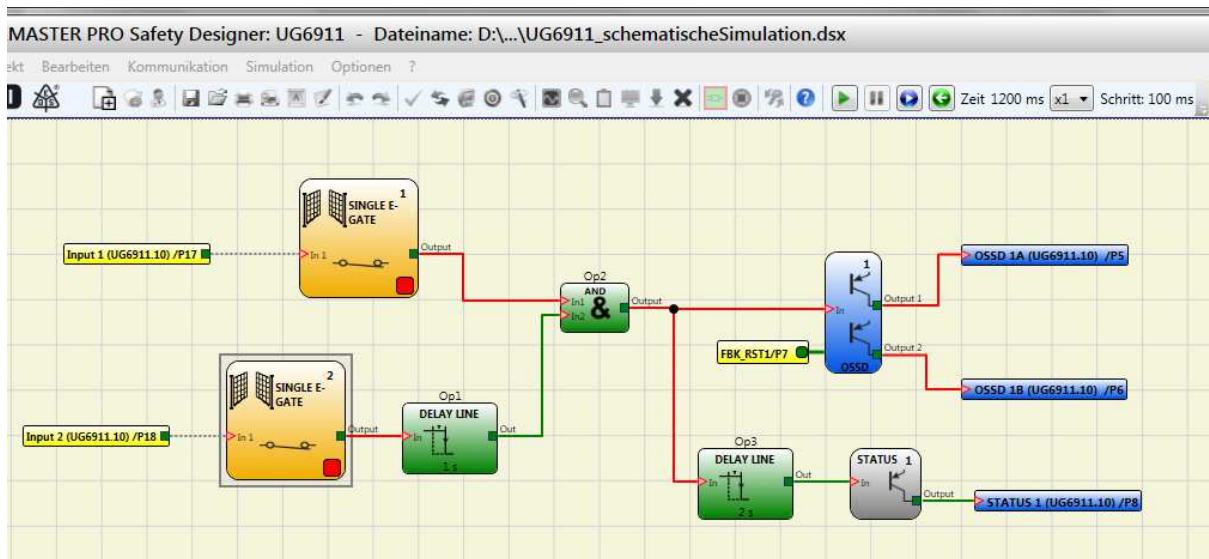



Figure 47 – Schematic Simulation

Click on the bottom right key of each input block to activate the respective output status (even when the simulator is not running, i.e. when the time is not elapsing: in this case the simulation is "static"). If the key turns red when you click on it, the output will be set to level LL0. If it turns green, the output will be set to level LL1.

In some function blocks, such as "speed control" or "lock_feedback", for example, the key is grey. This indicates that the value must be entered manually in a specific pop-up window. The type of value to be entered differs according to the type of function block (e.g., in a "speed control" block you will need to enter the frequency).

Graphic Simulation

Click on the icon  to start the graphic simulation.

Graphic simulation can be used to display the signal pattern over time in a graph. First you must define the stimuli in a specific text file: this means defining the trend over time in the waveforms used as inputs (stimuli). Based on the stimuli file created, the simulator injects these into the diagram and displays the traces required in order to perform the simulation.

When the simulation is complete, a graph like the one shown below is automatically displayed. From the graph you can print the traces displayed ("Print"), save the results in order to load them again later (Save) or display other traces ("Change visibility"). The names of the traces match the description of the function blocks.

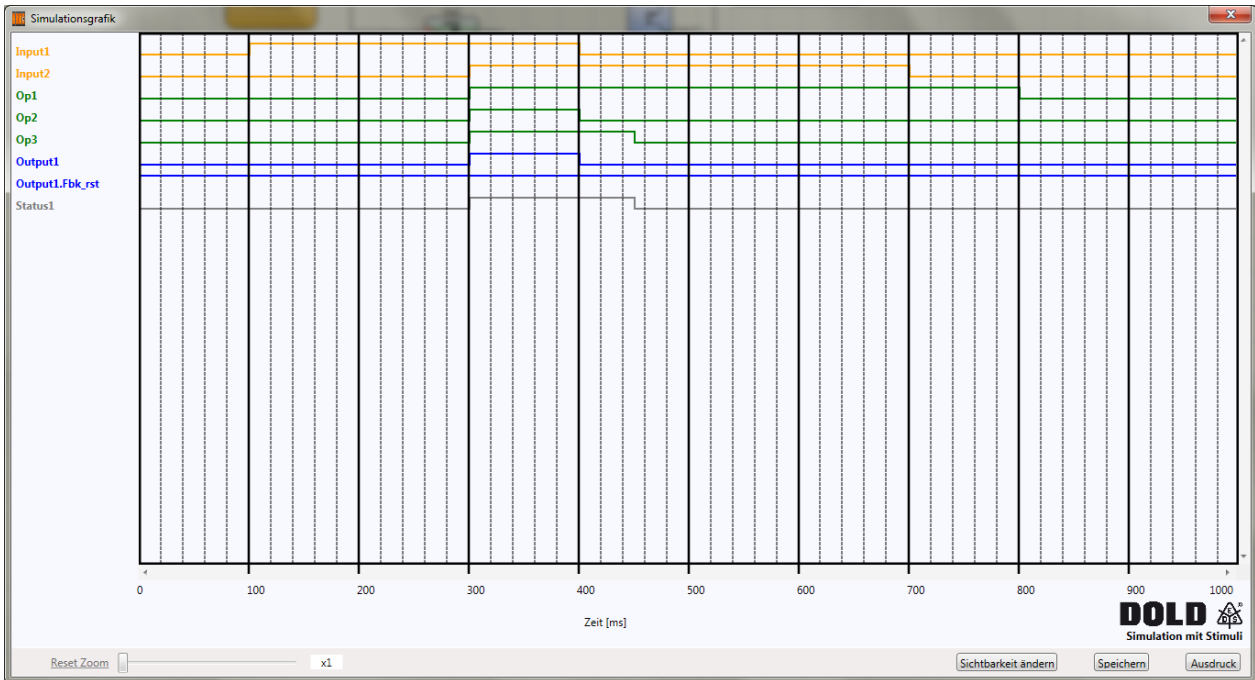

Figure 50 – Example of a result of the graphic simulation

Click on the icon  to display the page shown below.

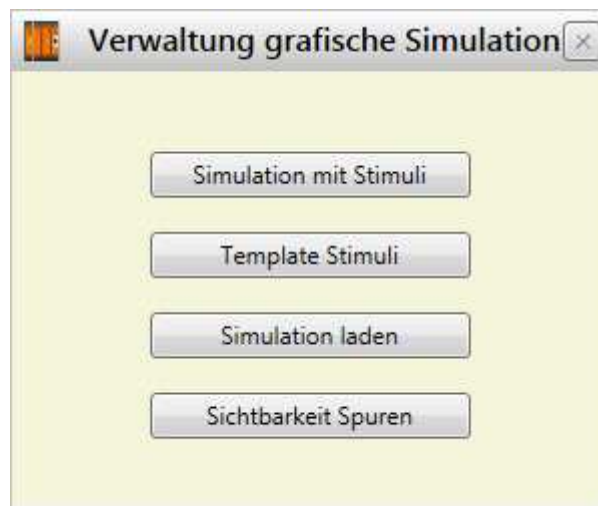
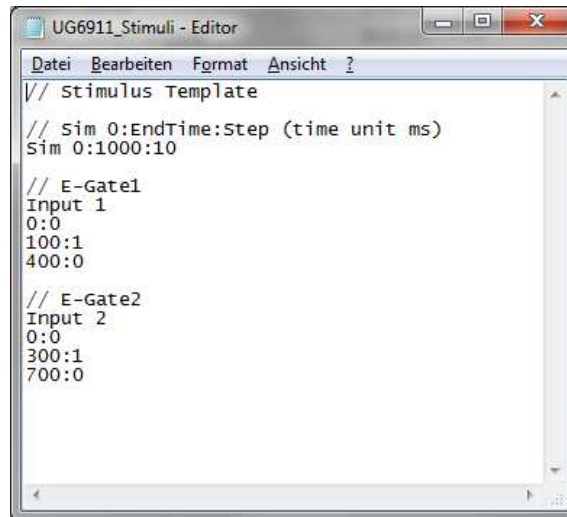

Figure 51 – Menu for selecting the graphic simulation mode

Description of the menu items

Template Stimuli:

Used to save the template file with the desired name and disk location. This file will contain the names of the signals as shown in the diagram 52. Now you may use a text editor to enter the status of the input signals at a given moment in time as well as the duration of the simulation and the time step to be used.



```
UG6911_Stimuli - Editor
Datei Bearbeiten Format Ansicht ?
// Stimulus Template
// Sim 0:EndTime:Step (time unit ms)
Sim 0:1000:10
// E-Gate1
Input 1
0:0
100:1
400:0
// E-Gate2
Input 2
0:0
300:1
700:0
```

Figure 52 – Example of complete template file

Simulation with Stimuli:

Used to load a template file (suitably completed) and, once loaded, to immediately start the simulation.

At the end of the simulation, a graph is displayed with the resulting signals.

Load Simulation:

Used to load a previously completed simulation, provided at least one has been saved.

Traces Visibility:

Used to select the traces (signal waveforms) to be displayed in the graph. When you press this key, it opens a pop-up window as shown in Figure 53 from which you can add or remove traces to or from the graph.



Bild 53 – Traces visibility



- ➔ The traces that can be added to the graph are shown in the box on the left. The traces currently displayed and which can be removed from the graph are shown in the box on the right.

ACCESSORIES AND SPARE PARTS

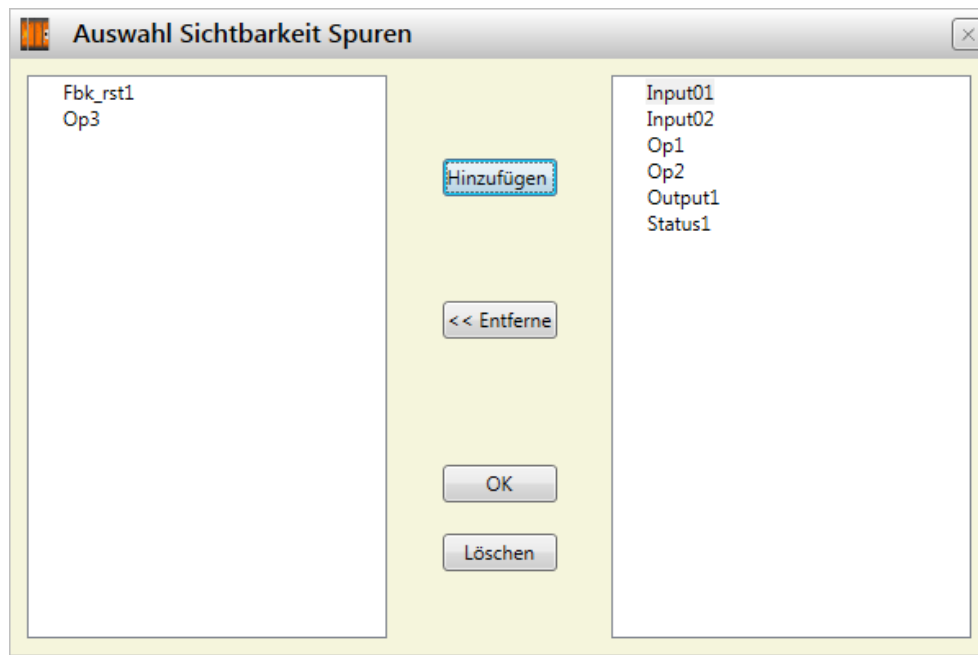
MODEL	DESCRIPTION	Reference
UG6911.10	Control unit (8 Input / 2 dual channel OSSD), with software SAFEMASTER PRO DESIGNER	0063818
UG6916.10	Input/Output module (8 Input / 2 dual channel OSSD)	0063819
UG6913.08	Input module (8 inputs)	0063820
UG6913.12	Input module (12 inputs)	0064865
UG6913.16	Input module (16 inputs)	0063821
UG6912.02	Output module OSSD (2 dual channel OSSD)	0063822
UG6912.04	Output module OSSD (4 dual channel OSSD)	0063823
UG6912.14	Output module relay (1 safety relay output)	0063824
UG6912.28	Output module relay (2 safety relay output)	0063825
UG6914.04/000	Output module relay (4 safety relay output)	0066057
UG6914.04/008	Output module relay (4 safety relay output + 8 status outputs)	0065990
UG6917/002	speed monitoring module (for 2 proximity switches)	0066059
UG6917/102	speed monitoring module (for 2 proximity switches + 1 TTL encoder)	0066060
UG6917/112	speed monitoring module (for 2 proximity switches + 2 TTL encoder)	0066061
UG6917/202	speed monitoring module (for 2 proximity switches + 1 HTL encoder)	0066062
UG6917/222	speed monitoring module (for 2 proximity switches + 2 HTL encoder)	0066063
UG6917/302	speed monitoring module (for 2 proximity switches + 1 Sin/Cos Encoder)	0066064
UG6917/332	speed monitoring module (for 2 proximity switches + 2 Sin/Cos Encoder)	0065992
UG6918	Bus Extender	0064866
UG6951	Fieldbus module CanOpen	0063828
UG6952	Fieldbus module PROFIBUS DP	0063826
UG6954	Fieldbus module PROFINET	0064861
UG6955	Fieldbus module Ethernet IP	0064862
UG6956	Fieldbus module EtherCAT	0064863
UG6957	Fieldbus module Universal Serial Bus (USB)	0064864
OA6911	memory chip	0063829
OA6920	USB-Connection cable for PC	0064160
BU6921	Mounting set IN-RAIL-Bus 250mm for DIN 7,5mm Rail	0064244
BU6922	Mounting set IN-RAIL-Bus 250mm for DIN 15mm Rail	0064245
PN6919	Software SAFEMASTER PRO Designer	0064246

Please, visit the website www.dold.com for the list of the authorized representative of each Country.

LIABILITY

-  Precise, complete compliance with all standards, instructions and warnings in this handbook is essential for the correct operation of the device. DOLD therefore declines any responsibility for all and anything resulting from failure to comply with all or some of the aforesaid instructions.
-  DOLD takes no responsibility for the solutions created by customers concerning the circuits, the electrical diagrams and the chosen configuration parameters for their application.
The implemented circuits and electrical diagrams and the system configuration parameter values, including those of SAFEMASTER PRO, are fully under the responsibility of the user.

Characteristics are subject to change without prior notice. No part of this document may be reproduced unless authorized by DOLD.

DECLARATION OF CONFORMITY

EG-Konformitätserklärung
Declaration of Conformity
Déclaration de conformité européenne



Hersteller: E. Dold & Söhne KG Ort, Datum: Furtwangen, 21.1.2015
 Manufacturer: 78120 Furtwangen Place, Date: / Lieu, date:
 Fabricant: Bregstr. 18 Germany

Produktbezeichnung: **Safemaster Pro**
 Product description: / Désignation du produit:

Das bezeichnete Produkt stimmt mit den Vorschriften folgender Europäischer Richtlinien überein:
 We declare that this product conforms to the following European Standards: / Le produit désigné est conforme aux instructions des directives européennes.

2004/108/EG	EMV-Richtlinie: EMC-Directive: / Directives-CEM:
2006/42/EG	Maschinennichtlinie: Machinery directive: / Directives Machines:
2006/95/CE	Niederspannungsrichtlinie: Low voltage directive: / Directives basse tension:

stimmt mit folgender Normen überein:
 and complies with the following standards: / et est conforme aux normes suivantes:

DIN EN 61131-2 (2007)	Speicherprogrammierbare Steuerungen, Teil 2: Betriebsmittelanforderungen und Prüfungen Programmable controllers, part 2: Equipment requirements and tests Automates programmables, partie 2: Spécifications et essais des équipements
DIN EN ISO 13849-1 (2008)	Sicherheit von Maschinen, Sicherheitsbezogene Teile von Steuerungen, Teil 1: Allgemeine Gestaltungsleitsätze Safety of machinery: Safety related parts of control systems, Part 1: General principles for design Sécurité des machines: Parties des systèmes de commande relatives à la sécurité, partie 1: Principes de conception généraux
DIN EN 61496-1 (2013)	Sicherheit von Maschinen - Berührungslos wirkende Schutzeinrichtungen, Teil 1: Allgemeine Anforderungen und Prüfungen Safety of machinery: Electro-sensitive protective equipment. Part 1: General requirements and tests. Sécurité des machines: Équipements de protection électro-sensibles, Partie 1: Prescriptions générales et essais.
DIN EN 61508	Funktionale Sicherheit sicherheitsbezogener elektrischer/elektronischer/programmierbarer elektronischer Systeme Functional safety of electrical/electronic/programmable electronic safety-related systems Sécurité fonctionnelle des systèmes électriques/électroniques/programmables relatifs à la sécurité
DIN EN 61508-1 (2010)	Teil 1: Allgemeine Anforderungen. part 1: General requirements. partie 1: Prescriptions générales.
DIN EN 61508-2 (2010)	Teil 2: Anforderungen an sicherheitsbezogene elektrische/elektronische/programmierbare elektronische Systeme, part 2: Requirements for electrical/electronic/programmable electronic safety-related systems. partie 2: Prescriptions pour les systèmes électriques/électroniques/programmables relatifs à la sécurité.
DIN EN 61508-3 (2010)	Teil 3: Anforderungen an Software part 3: Software requirements. partie 3: Prescriptions concernant les logiciels
DIN EN 61508-4 (2010)	Teil 4: Begriffe und Abkürzungen part 4: Definitions and abbreviations partie 4: Définitions et abréviations
DIN EN 61784-3 (2008)	Industrielle Kommunikationsnetze - Profile, Teil 3: Funktional sichere Übertragung bei Feldbussen - Allgemeine Regeln und Profilstellungen Digital data communication for measurement and control, Part 3: Functional safety fieldbuses. Communications numériques pour les systèmes de mesure et de commande, partie 3: profils pour les communications de sécurité fonctionnelle dans les réseaux industriels
DIN EN 62061 (2005)	Sicherheit von Maschinen - Funktionale Sicherheit sicherheitsbezogener elektrischer, elektronischer und programmierbarer elektronischer Steuerungssysteme Safety of machinery. Functional safety of safety-related electrical, electronic and programmable electronic control systems Sécurité des machines. Sécurité fonctionnelle des systèmes de commande électriques, électroniques programmables relatifs à la sécurité

erreicht einen Sicherheitslevel entsprechend: SIL 3 / SILCL 3 / PLe / Cat. 4 / Type 4 (siehe entsprechende Normen)
 reaching a safety level corresponding to: SIL 3 / SILCL 3 / PLe / Cat. 4 / Type 4 (see related standards)
 atteint un niveau de sécurité correspondant à: SIL 3 / SILCL 3 / PLe / Cat. 4 / Type 4 (voir normes correspondantes)

Die Übereinstimmung eines Baumusters des bezeichneten Produktes mit der oben genannten Maschinen-Richtlinie wurde bescheinigt durch:

Consistency of a production sample with the marked product in accordance to the above machines directive has been certified by:
 La conformité d'un échantillon du produit désigné aux directives machine susmentionnées a été certifiée par:
 TÜV SÜD Rail GmbH - Ridlerstrasse 65 - D-80339 - München - Germany

Gamal Hagar
 Entwicklungsleiter / R&D Manager

ppa. Christian Dold
 Produktmanagement

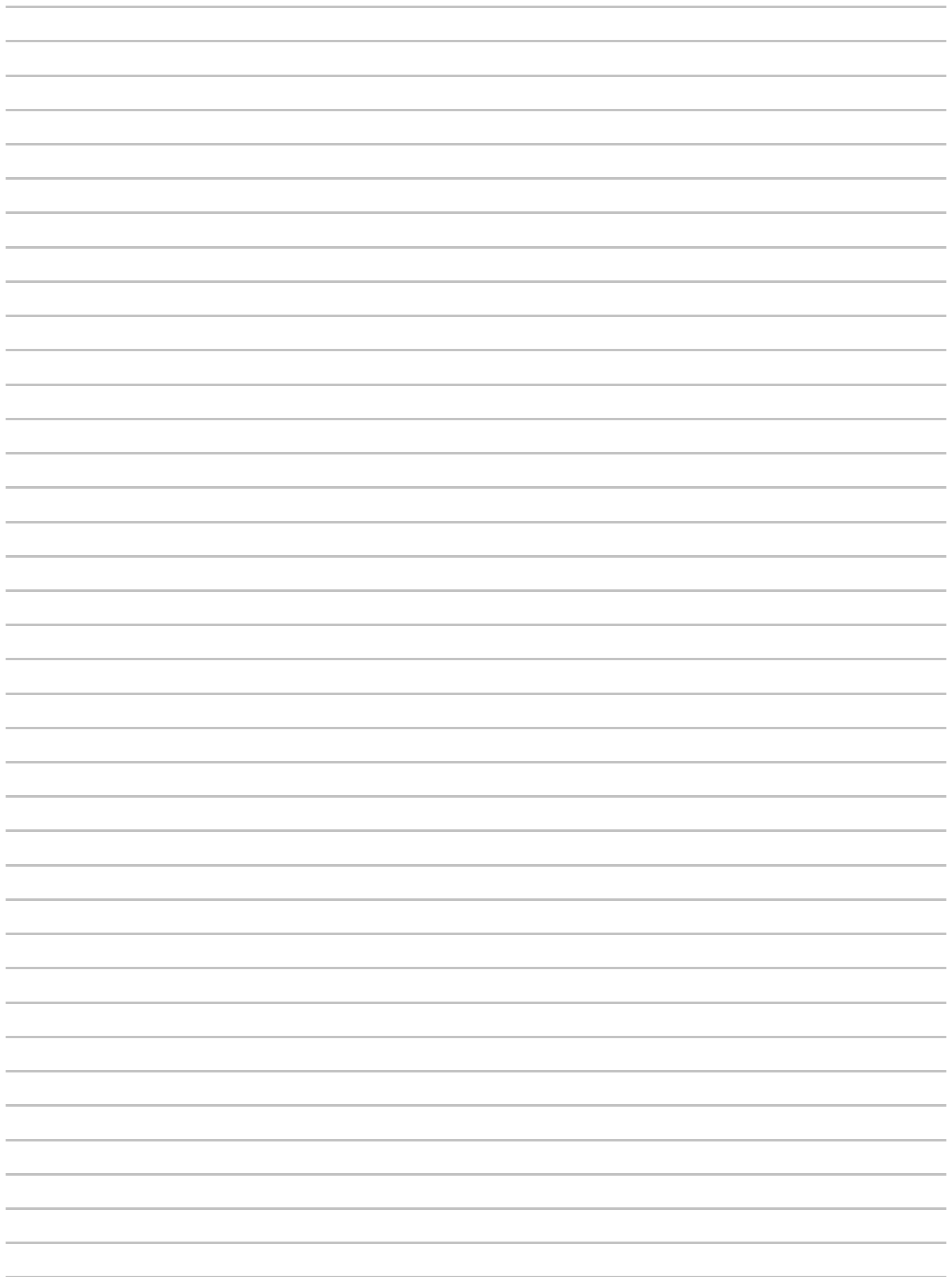

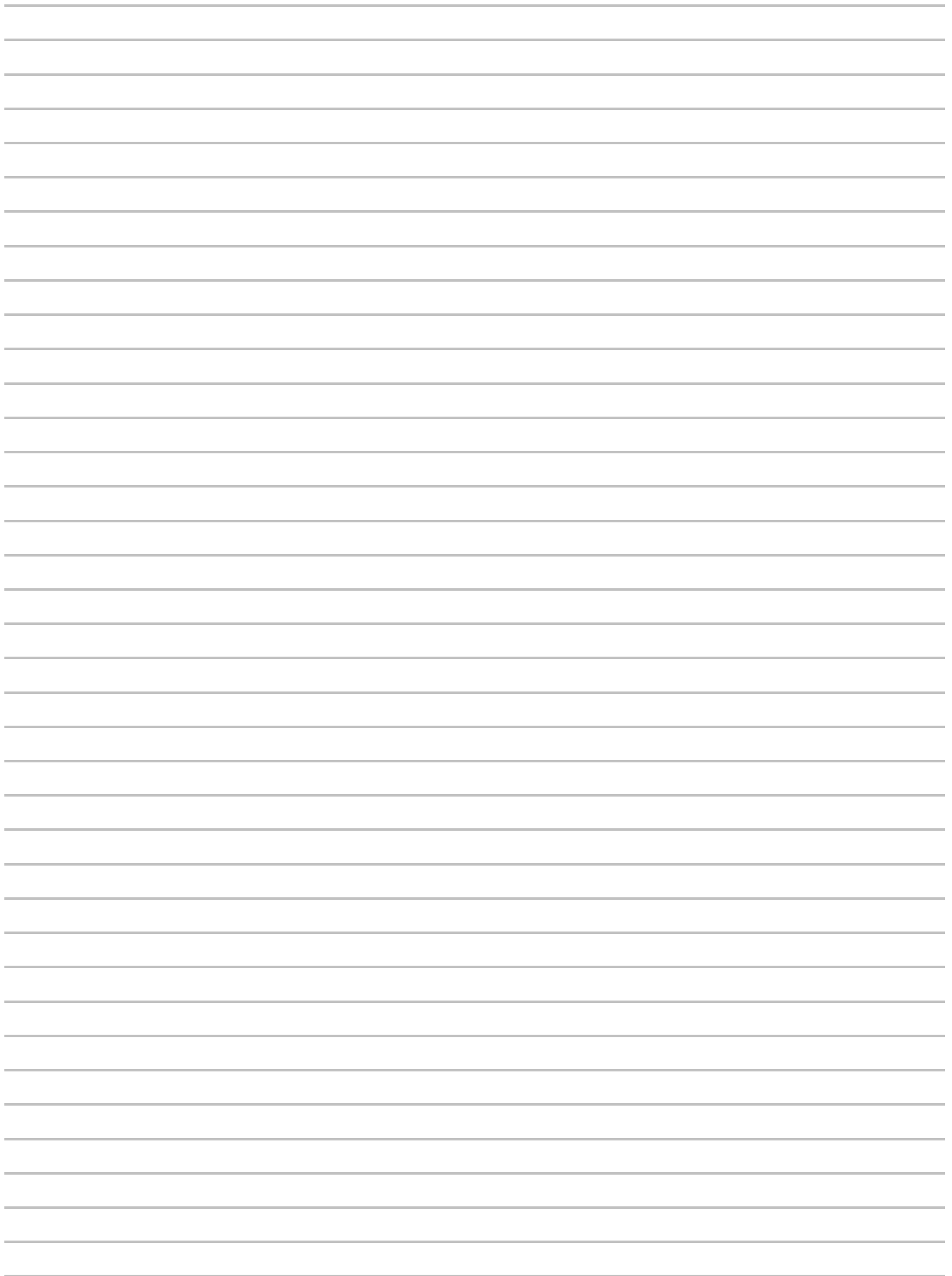

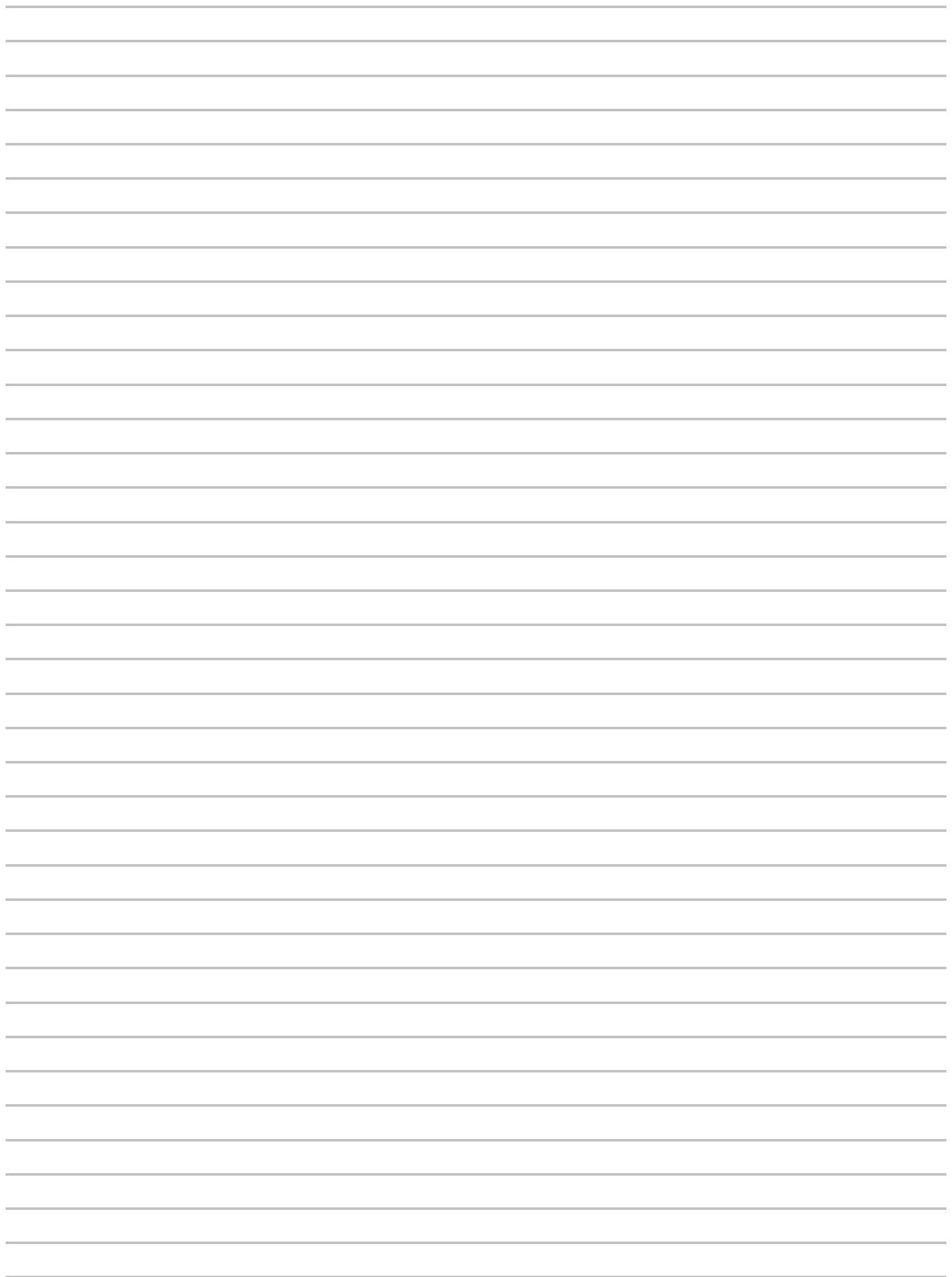

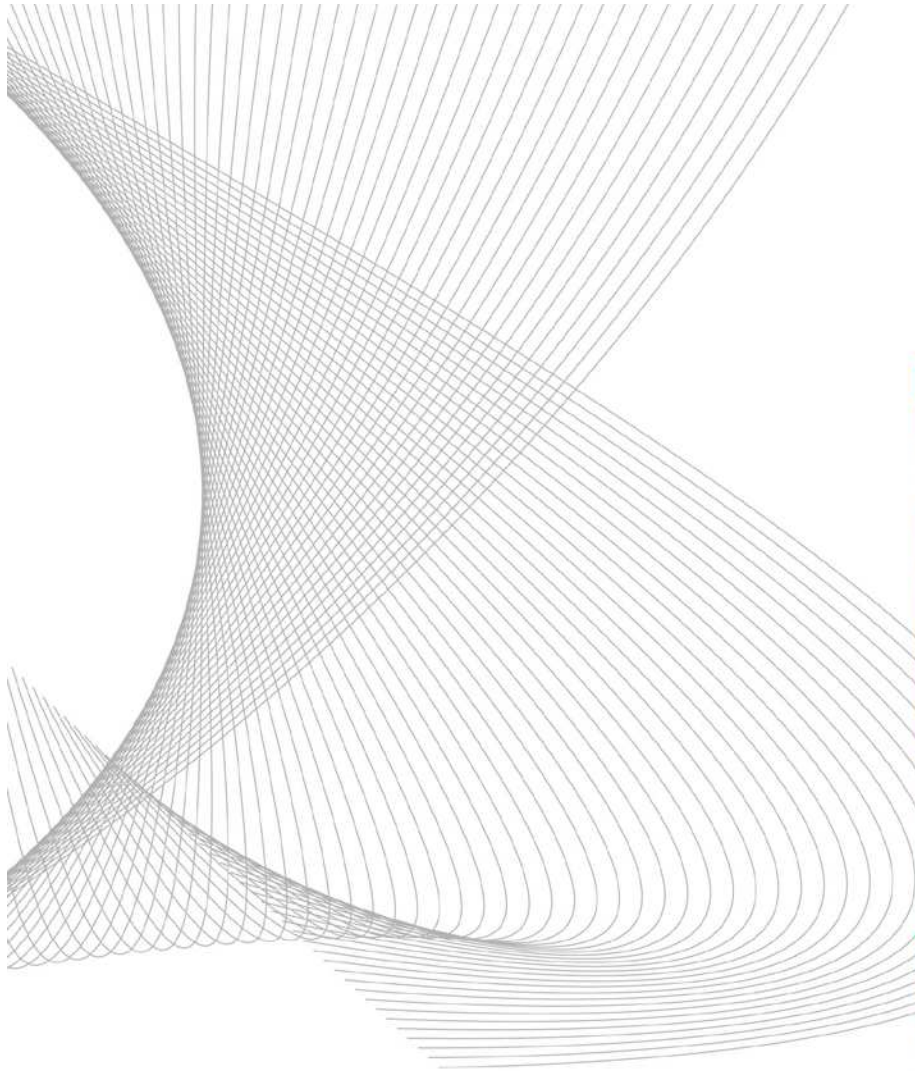

DOLD



E. DOLD & SÖHNE KG
Postfach 1251 • D-78114 Furtwangen
Phone +49 7723 6540 • Fax +49 7723 654356
dold-relays@dold.com • www.dold.com